

Station locations for SR03 : BINDOFF January, 1994

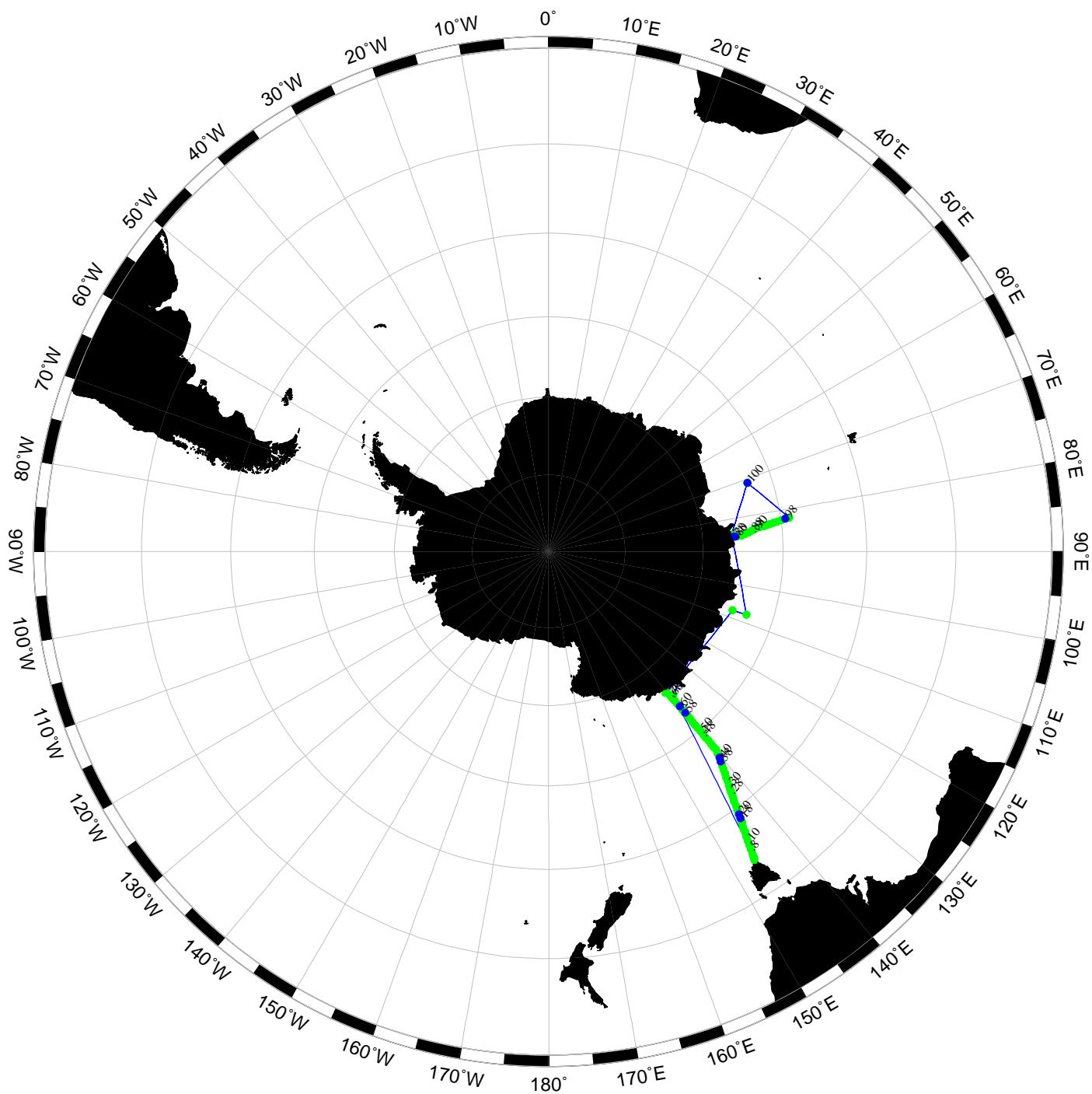

Aurora Australis Marine Science Cruise AU9407 - Oceanographic Field Measurements and Analysis

MARK ROSENBERG

Antarctic CRC, GPO Box 252C, Hobart, Australia

RUTH ERIKSEN

Antarctic CRC, GPO Box 252C, Hobart, Australia

STEVE BELL

Antarctic CRC, GPO Box 252C, Hobart, Australia

NATHAN BINDOFF

Antarctic CRC, GPO Box 252C, Hobart, Australia

STEVE RINTOUL

*Antarctic CRC, GPO Box 252C, Hobart, Australia,
CSIRO Division of Oceanography, Hobart, Australia*

ABSTRACT

Oceanographic measurements were conducted in January 1994 along WOCE Southern Ocean meridional section SR3 between Tasmania and Antarctica, and along a northward section lying between 82 and 86°E and crossing the Princess Elizabeth Trough. Additional measurements were made at mooring locations, and at a time series station. A total of 102 CTD vertical profile stations were taken, most to near bottom. Over 2000 Niskin bottle water samples were collected for the measurement of salinity, dissolved oxygen, nutrients, dissolved inorganic and organic carbon, carbon 13, dimethyl sulphide/dimethyl sulphonioacetate, iodate/iodide, and biological parameters, using a 24 bottle rosette sampler. Measurement and data processing techniques are described, and a summary of the data is presented in graphical and tabular form.

1 INTRODUCTION

Marine science cruise AU9407 of the Cooperative Research Centre for the Antarctic and Southern Ocean Environment (Antarctic CRC) was conducted aboard the Australian Antarctic Division vessel RSV Aurora Australis from January to March 1994. The first major constituent of the cruise was the collection of oceanographic data relevant to the Australian Southern Ocean WOCE Hydrographic Program, along WOCE section SR3 (Figure 1). The primary scientific objectives of this program are:

1. to estimate the interbasin exchange of heat, freshwater and other properties south of Australia, and the seasonal and interannual variability of this exchange;
2. to investigate the mechanisms responsible for the formation of deep and intermediate water masses in the Southern Ocean, and to identify the ventilation pathways that newly formed water masses follow into the ocean interior;
3. in conjunction with current meter data, to determine the importance of eddy heat and momentum fluxes in the dynamics and thermodynamics of the Antarctic Circumpolar Current south of Australia.

Section SR3 was occupied twice previously, in the spring of 1991 (Rintoul and Bullister, in prep.), and in the autumn of 1993 (Rosenberg et al., 1995).

The second major constituent of the cruise was oceanographic measurements along the Princess Elizabeth Trough section (PET). This is a short hydrographic section from the West Ice Shelf, at approximately 85°E, across the trough and along the ridge of the Kerguelen Plateau, connecting the earlier hydrographic section of Speer and Forbes (1994) to the Antarctic continent, and passing over an array of five current meter moorings deployed by MAFF (Dickson, 1993) (Figure 1). The primary aims of the PET measurements are:

1. to estimate the interbasin transport through the Princess Elizabeth Trough and the effect of the Kerguelen Plateau on the Circumpolar Current;
2. to investigate the distribution and properties of Antarctic Bottom waters;
3. in conjunction with other sections, provide additional constraints on the transport of heat and freshwater.

Additional measurements were made at two upward looking sonar mooring sites, a single bottom pressure recorder mooring location, and at a time series station. This latter station is to be occupied several times per year in collaboration with French and Japanese scientists (P. Treguer, D. Mackey, H. Marchant, pers. comms).

The cruise discussed in this report is the second in a series of Southern Ocean marine science cruises, the first being described in Rosenberg et al. (1995). The report describes the collection of oceanographic data from the two transects, and the chemical analysis and data processing methods employed. Brief comparisons are also made with existing historical data. All information required for use of the data set is presented in tabular and graphical form.

2 CRUISE ITINERARY

The cruise commenced with a north to south traverse of section SR3. A bottom pressure recorder mooring (Table 4) was recovered along the way, at the northern end of the section, and replaced by a new instrument. An attempt to recover two bottom pressure recorders at the southern end of the section was unsuccessful; an additional recorder was deployed in the vicinity. Following completion of SR3, the ship steamed west to deploy two upward looking sonar moorings, then continued west to the Princess Elizabeth Trough; the PET section was traversed from south to north. Following occupation of the time series station at the end of January, the major planned oceanographic component of the cruise was completed. Through most of February, personnel transfers and cargo operations were conducted at the Australian Antarctic bases (Table 1). The ship returned east to Dumont D'Urville in late February to collect trawl gear, delivered by the French supply ship L'Astrolabe from Hobart to the French base. The old bottom pressure recorders at the southern end of the SR3 section were relocated, and several unsuccessful attempts were made to trawl for the moorings. The ship then returned to Hobart.

3 CRUISE SUMMARY

3.1 CTD casts

In the course of the cruise, 102 CTD casts were completed at 83 different sites along the SR3 and PET sections (Figure 1) (Table 2), plus additional locations, at a typical spacing of 30 nautical miles between sites along the sections, and with most casts reaching to within 15 m of the sea floor (Table 2). Sea ice and weather conditions did not restrict the southern extent of SR3, and the section was successfully closed off on the Antarctic continental shelf. The section was continued into the D'Urville Trough on the continental shelf, where three additional casts were taken to trace possible formation

sites for Antarctic bottom water. Of the 58 different locations along SR3 where casts were taken, a shallow and deep cast pair were taken at 13 of the locations, both to increase the vertical resolution of Niskin bottle sample data, and to ensure a sufficient volume of water was obtained for the biology programs.

Prior to starting the PET section, a bathymetric survey was taken up the Antarctic continental slope onto the shelf, in order to determine the best locations of casts over the shelf and slope on the northward transect. CTD casts were taken at 21 different locations along the PET transect, commencing approximately 19 nautical miles north of the West Ice Shelf. Shallow/deep cast pairs were performed at 3 of the locations.

Additional CTD casts were performed at the two upward looking sonar mooring sites midway between SR3 and PET, and at the unretrieved bottom pressure recorder site at the southern end of SR3 (Figure 1). A shallow/deep CTD cast pair was taken at the time series station at approximately 63°S 71°E (Figure 1).

Table 1: Summary of cruise itinerary.

Expedition Designation

Cruise AU9407 (cruise acronym SHAM), encompassing WOCE section SR3 and Princess Elizabeth Trough section (PET)

Chief Scientists

Bronte Tilbrook, CSIRO
Nathan Bindoff, Antarctic CRC

Ship

RSV Aurora Australis

Ports of Call

Mawson
Law Base
Davis
Casey
Dumont D'Urville

Cruise Dates

January 1 to March 1, 1994

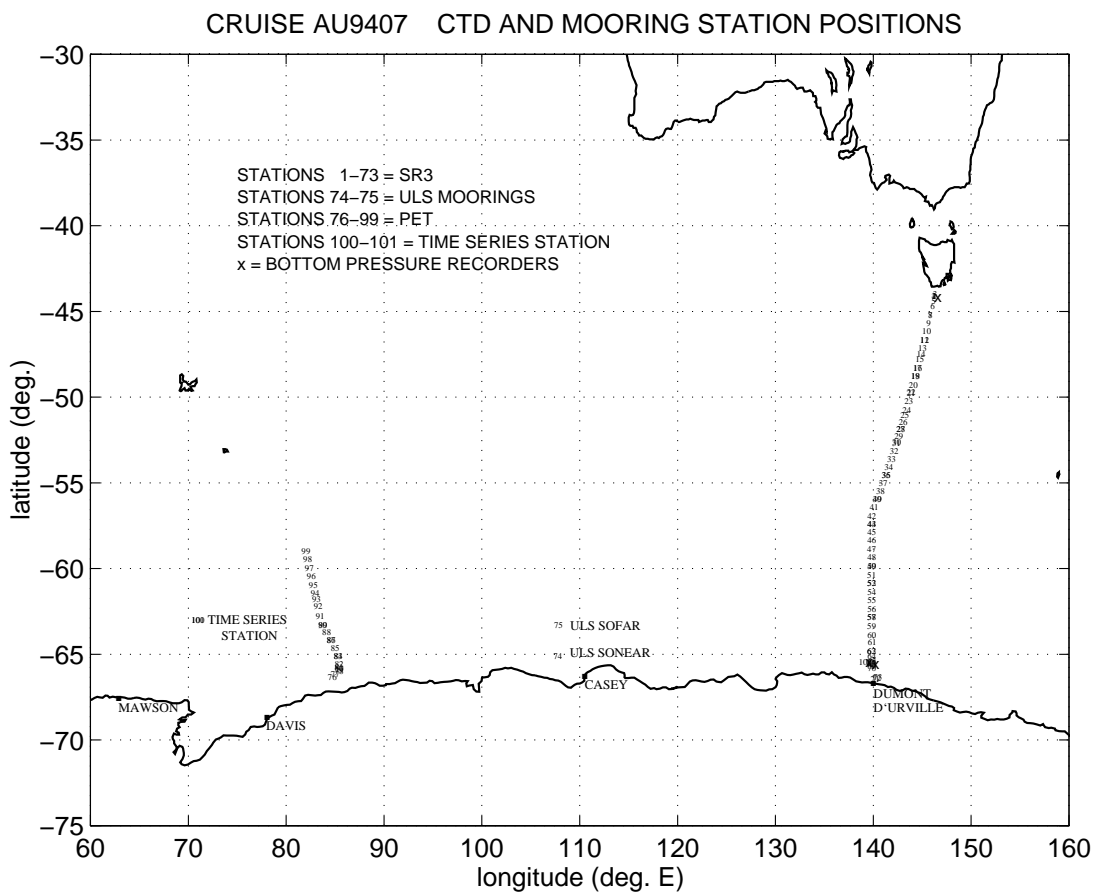

Figure 1: CTD station positions for RSV Aurora Australis cruise AU9407 along WOCE transect SR3, and along the PET transect. Additional CTD sites are shown at the time series station (TS), at the 2 upward looking sonar mooring locations (ULS), and at the unretrieved bottom pressure recorder site (BPR).

3.2 Water samples from CTD casts

Over 2000 Niskin bottle water samples were collected for the measurement of salinity, dissolved oxygen, nutrients, dissolved inorganic carbon, ^{13}C , dimethyl sulphide/dimethyl sulphonioacetate, dissolved organic carbon, iodate/iodide, and biological parameters, using a 24 bottle rosette sampler. Test samples at a few stations were drawn for the analysis of ^{18}O , and alkalinity. Table 3 provides a summary of samples drawn at each station. Principal investigators for the various water sampling programmes are listed in Table 6a. For all stations, the different samples were drawn in a fixed sequence, as discussed in section 4.1.3. The methods for drawing the salinity, dissolved oxygen and nutrient samples are discussed in section 4.1.4.

Salinity, dissolved oxygen and nutrients: Samples were drawn from most stations for salinity, dissolved oxygen and nutrient analyses. Salinity and dissolved oxygen hydrology data was further used for the calibration of CTD salinity and dissolved oxygen data; nutrient samples were analysed for concentration of orthophosphate, nitrate plus nitrite, and reactive silicate.

Dissolved inorganic carbon: Samples were drawn for total dissolved inorganic carbon analysis approximately every second station. In general, salinity and oxygen properties determined the Niskin sampling strategy, thus the sampling depths were not always best suited to the resolution of dissolved inorganic carbon gradients in the top 300 m of the water column. Results from these analyses are reported elsewhere (Tilbrook, pers. comm.), and are not discussed further in this report.

^{13}C and ^{18}O , and alkalinity: Samples were drawn for ^{13}C analysis from multiple depths on the SR3 transect and at the time series station; surface ^{13}C samples were taken on both SR3 and PET. Samples for ^{18}O analysis were drawn on the PET transect only; alkalinity samples were taken only on PET and at the time series station. These sample sets are not discussed further in this report.

Dimethyl sulphide/dimethyl sulphonioacetate (i.e. DMS and DMSP): These samples were drawn on the SR3 transect only. The data is not discussed further in this report.

Dissolved organic carbon: Six SR3 locations, plus the time series station, were sampled for dissolved organic carbon. Additional surface samples were taken at several of the PET stations.

Iodate/iodide: These samples were drawn on both the SR3 and PET transects; results are not discussed in this report.

Primary productivity: For casts taken during daylight hours on the SR3 transect (and at the time series station), samples were drawn for analysis of primary productivity and suspended particle size. These samples were taken from the shallowest four Niskin bottles. At most primary productivity sites, a Seabird "Seacat" CTD was deployed to obtain vertical profiles of photosynthetically active radiation (p.a.r.) and fluorescence from the top part of the water column. These data are not discussed further in this report.

Biological sampling: Several different analyses were performed on the biological water samples, as follows:

- (i) pigments (using high performance liquid chromatography)
- (ii) algal counts (lugols iodine fixed)
- (iii) cyanobacteria counts
- (iv) total algal counts
- (v) osmicated samples, for looking at ultrastructure of algae by electron microscopy
- (vi) cultured samples, growing various flagellates
- (vii) coccolith counts
- (viii) parmales cultures
- (ix) flavobacteria

Biological samples were usually drawn from the shallowest four or five Niskin bottles, except for flavobacteria (up to 40 litres collected from a single depth). These data are not discussed further in this report.

Table 2 (following 3 pages): Summary of station information for RSV Aurora Australis cruise AU9407. The information shown includes time, date, position and ocean depth for the start of the cast, at the bottom of the cast, and for the end of the cast. The maximum pressure reached for each cast, and the altimeter reading at the bottom of each cast (i.e. elevation above the bed) are also included. Missing ocean depth values are due to noise from the ship's bow thrusters, as discussed in Appendix 2, section A2.3. For casts which do not reach to within 100 m of the bed (i.e. the altimeter range), there is no altimeter value. For station names, TEST is a test cast, ULS is an upward looking sonar mooring site, TS is the time series station, and BPR is a bottom pressure recorder mooring location. Note that all times are UTC (i.e. GMT). CTD unit 6 (serial no. 2568) was used for all stations.

station number	START					maxP (dbar)	BOTTOM					END			
	time	date	latitude	longitude	depth(m)		time	latitude	longitude	depth(m)	altimeter(m)	time	latitude	longitude	depth(m)
1 TEST	1954	1-JAN-94	44:07.13S	146:12.68E	994	1002	2030	44:07.33S	146:12.97E	1034	35.0	2114	44:07.65S	146:13.17E	1066
2 TEST	0229	2-JAN-94	44:07.44S	146:12.94E	1041	906	0312	44:07.59S	146:12.76E	1040	36.5	0406	44:07.76S	146:12.34E	1060
3 SR3	0733	2-JAN-94	43:59.97S	146:19.04E	248	212	0745	43:59.93S	146:19.18E	218	10.0	0814	43:59.82S	146:19.48E	188
4 SR3	1020	2-JAN-94	44:07.03S	146:13.35E	1015	1038	1100	44:07.14S	146:13.71E	1045	6.9	1222	44:06.61S	146:13.95E	1026
5 SR3	1437	2-JAN-94	44:22.85S	146:10.57E	2351	2346	1553	44:22.45S	146:09.88E	-	16.0	1712	44:22.00S	146:09.80E	-
6 SR3	1952	2-JAN-94	44:43.08S	146:02.64E	3211	3254	2105	44:43.30S	146:02.70E	3232	4.9	2230	44:43.43S	146:02.76E	3237
7 SR3	0144	3-JAN-94	45:12.92S	145:51.27E	2859	206	0156	45:12.96S	145:51.21E	-	-	0218	45:12.91S	145:51.17E	-
8 SR3	0312	3-JAN-94	45:12.82S	145:51.28E	2859	2888	0434	45:12.76S	145:51.06E	2879	15.0	0551	45:12.45S	145:50.88E	-
9 SR3	0901	3-JAN-94	45:41.87S	145:39.65E	2020	2006	0956	45:42.08S	145:40.20E	2020	15.0	1109	45:42.31S	145:41.01E	2040
10 SR3	1424	3-JAN-94	46:10.33S	145:27.67E	2776	2752	1546	46:10.28S	145:27.83E	2745	15.0	1712	46:10.36S	145:27.96E	2745
11 SR3	2030	3-JAN-94	46:39.16S	145:15.38E	3366	206	2039	46:39.15S	145:15.40E	-	-	2054	46:39.18S	145:15.35E	-
12 SR3	2138	3-JAN-94	46:39.07S	145:15.16E	3366	3388	2247	46:38.88S	145:15.08E	-	18.1	0021	46:38.84S	145:15.03E	3366
13 SR3	0324	4-JAN-94	47:08.67S	145:03.06E	4610	4526	0515	47:08.38S	145:02.19E	-	22.0	0718	47:08.20S	145:01.76E	-
14 SR3	1123	4-JAN-94	47:28.15S	144:54.28E	4413	4438	1258	47:28.17S	144:55.08E	-	13.5	1458	47:28.03S	144:55.68E	4330
15 SR3	1727	4-JAN-94	47:48.25S	144:44.48E	3957	3972	1857	47:48.12S	144:46.07E	3915	16.0	2038	47:47.81S	144:46.68E	3853
16 SR3	0008	5-JAN-94	48:18.83S	144:32.14E	4092	206	0025	48:18.70S	144:32.25E	-	-	0051	48:18.41S	144:32.34E	4092
17 SR3	0206	5-JAN-94	48:18.90S	144:31.73E	4143	4132	0358	48:18.27S	144:32.50E	4143	15.0	0530	48:17.77S	144:32.95E	4206
18 SR3	0835	5-JAN-94	48:46.93S	144:19.11E	4164	156	0840	48:46.84S	144:18.99E	-	-	0852	48:46.75S	144:18.82E	4164
19 SR3	0912	5-JAN-94	48:46.53S	144:18.73E	4174	4150	1044	48:45.68S	144:18.40E	4192	17.0	1221	48:44.79S	144:18.15E	4040
20 SR3	1549	5-JAN-94	49:16.17S	144:05.64E	4237	4278	1715	49:15.97S	144:04.98E	4216	11.0	1850	49:15.61S	144:04.65E	4226
21 SR3	2203	5-JAN-94	49:45.09S	143:52.10E	3553	158	2213	49:45.02S	143:52.09E	-	-	2225	49:44.90S	143:52.14E	3553
22 SR3	2313	5-JAN-94	49:43.88S	143:52.41E	3553	3676	0020	49:43.80S	143:52.12E	-	17.0	0152	49:43.53S	143:51.80E	-
23 SR3	1811	6-JAN-94	50:14.06S	143:38.95E	3729	3802	1922	50:14.25S	143:39.48E	3729	13.4	2048	50:14.12S	143:40.30E	3729
24 SR3	0043	7-JAN-94	50:45.75S	143:24.88E	3853	4054	0215	50:46.03S	143:26.38E	-	15.0	0348	50:46.23S	143:27.58E	-
25 SR3	0604	7-JAN-94	51:01.99S	143:14.29E	3729	3842	0724	51:02.53S	143:15.04E	3833	17.6	0900	51:03.09S	143:15.73E	3755
26 SR3	1142	7-JAN-94	51:25.88S	143:02.40E	3729	3772	1322	51:26.28S	143:03.33E	3781	15.1	1457	51:26.55S	143:04.09E	-
27 SR3	1724	7-JAN-94	51:50.62S	142:49.69E	3159	56	1727	51:50.62S	142:49.69E	-	-	1731	51:50.68S	142:49.68E	3159
28 SR3	1752	7-JAN-94	51:51.07S	142:49.83E	3729	3648	1915	51:51.65S	142:49.95E	3605	17.0	2046	51:51.93S	142:50.12E	3688
29 SR3	2338	7-JAN-94	52:15.46S	142:37.53E	3470	3458	0112	52:15.86S	142:37.21E	-	15.0	0246	52:15.72S	142:37.38E	-
30 SR3	0509	8-JAN-94	52:38.34S	142:23.24E	3522	154	0515	52:38.41S	142:23.24E	-	-	0532	52:38.68S	142:23.08E	-
31 SR3	0614	8-JAN-94	52:39.41S	142:22.88E	3522	3456	0727	52:40.25S	142:22.35E	-	14.7	0853	52:40.68S	142:22.08E	-
32 SR3	1129	8-JAN-94	53:07.54S	142:07.94E	3170	3126	1308	53:08.97S	142:06.30E	3107	18.0	1440	53:10.02S	142:05.43E	3159
33 SR3	1708	8-JAN-94	53:34.86S	141:51.95E	2382	2516	1805	53:34.91S	141:52.01E	2538	13.0	1923	53:34.83S	141:52.36E	2486
34 SR3	2240	8-JAN-94	54:03.85S	141:35.79E	2693	2754	0002	54:03.39S	141:35.46E	2693	17.7	0117	54:03.15S	141:35.25E	2693
35 SR3	0424	9-JAN-94	54:31.99S	141:19.39E	2848	104	0428	54:31.95S	141:19.45E	-	-	0431	54:31.92S	141:19.42E	2848
36 SR3	0447	9-JAN-94	54:31.79S	141:19.31E	2797	2822	0549	54:31.18S	141:19.19E	2859	17.3	0711	54:30.40S	141:18.92E	2745

station number	START					maxP (dbar)	BOTTOM					END			
	time	date	latitude	longitude	depth(m)		time	latitude	longitude	depth(m)	altimeter(m)	time	latitude	longitude	depth(m)
37 SR3	1030	9-JAN-94	55:01.16S	141:00.58E	3263	3284	1149	55:00.73S	141:00.27E	3315	17.0	1309	55:00.54S	141:00.33E	3366
38 SR3	1611	9-JAN-94	55:29.83S	140:43.65E	3988	4112	1727	55:29.23S	140:43.33E	4092	18.6	1918	55:28.42S	140:42.33E	4195
39 SR3	0118	10-JAN-94	55:55.72S	140:24.42E	3729	154	0122	55:55.72S	140:24.40E	-	-	0138	55:55.72S	140:24.40E	-
40 SR3	0231	10-JAN-94	55:55.90S	140:24.06E	3729	3602	0352	55:56.05S	140:23.79E	3729	9.0	0524	55:56.08S	140:23.55E	3729
41 SR3	0821	10-JAN-94	56:26.28S	140:06.01E	4143	4166	1002	56:26.38S	140:05.84E	-	15.8	1154	56:27.00S	140:06.61E	4143
42 SR3	1514	10-JAN-94	56:55.46S	139:50.94E	4143	4188	1639	56:55.82S	139:52.16E	-	12.1	1820	56:55.92S	139:53.11E	-
43 SR3	2055	10-JAN-94	57:23.02S	139:50.86E	4143	206	2105	57:23.04S	139:50.87E	-	-	2120	57:23.05S	139:50.84E	-
44 SR3	2213	10-JAN-94	57:22.42S	139:51.08E	4143	4038	2345	57:22.02S	139:50.38E	-	17.9	0125	57:21.76S	139:49.29E	-
45 SR3	0411	11-JAN-94	57:51.52S	139:51.40E	4040	4172	0555	57:51.76S	139:51.84E	-	14.3	0730	57:52.24S	139:51.96E	4143
46 SR3	1029	11-JAN-94	58:20.61S	139:51.16E	3988	4030	1204	58:21.13S	139:52.02E	-	15.8	1344	58:21.49S	139:53.37E	3936
47 SR3	1901	11-JAN-94	58:51.28S	139:50.58E	3936	3998	2040	58:52.02S	139:50.35E	-	13.9	2227	58:52.88S	139:49.48E	3853
48 SR3	0107	12-JAN-94	59:20.87S	139:50.81E	4221	4216	0256	59:21.58S	139:50.16E	4169	7.1	0420	59:22.11S	139:50.65E	4169
49 SR3	0701	12-JAN-94	59:51.58S	139:51.28E	4485	204	0709	59:51.64S	139:51.43E	4485	-	0730	59:51.89S	139:51.85E	4485
50 SR3	0827	12-JAN-94	59:51.45S	139:50.90E	4485	4532	1009	59:51.71S	139:51.72E	4485	16.0	1156	59:52.35S	139:52.05E	4485
51 SR3	1459	12-JAN-94	60:21.36S	139:50.59E	4433	4492	1653	60:22.35S	139:49.60E	4444	15.7	1849	60:22.63S	139:48.03E	-
52 SR3	2141	12-JAN-94	60:51.05S	139:50.83E	4408	154	2150	60:51.10S	139:50.75E	4408	-	2206	60:51.10S	139:50.63E	4408
53 SR3	2243	12-JAN-94	60:51.14S	139:50.63E	4408	4450	0030	60:51.37S	139:50.61E	4402	16.8	0221	60:51.43S	139:51.13E	4408
54 SR3	0514	13-JAN-94	61:20.99S	139:50.92E	4351	4392	0714	61:20.89S	139:49.66E	4371	15.1	0909	61:21.28S	139:47.59E	4371
55 SR3	1250	13-JAN-94	61:51.11S	139:50.95E	4309	4342	1424	61:51.25S	139:50.85E	-	12.2	1550	61:51.26S	139:51.41E	4299
56 SR3	1930	13-JAN-94	62:21.22S	139:50.83E	3967	3988	2112	62:20.80S	139:50.68E	-	14.9	2301	62:20.37S	139:51.82E	3967
57 SR3	0311	14-JAN-94	62:50.94S	139:50.80E	3211	106	0314	62:50.92S	139:50.73E	-	-	0320	62:50.86S	139:50.63E	-
58 SR3	0340	14-JAN-94	62:50.69S	139:50.24E	3211	3230	0451	62:50.18S	139:49.29E	3211	12.9	0628	62:49.66S	139:47.82E	3211
59 SR3	0937	14-JAN-94	63:21.10S	139:50.70E	3812	3838	1059	63:21.07S	139:49.94E	3812	8.9	1224	63:20.83S	139:49.32E	3812
60 SR3	1541	14-JAN-94	63:52.03S	139:51.10E	3739	3756	1730	63:51.98S	139:50.29E	3739	13.9	1904	63:51.88S	139:50.21E	3739
61 SR3	2139	14-JAN-94	64:16.89S	139:52.08E	3470	3478	2310	64:17.14S	139:53.26E	3470	13.9	0042	64:17.00S	139:55.22E	3470
62 SR3	0414	15-JAN-94	64:49.26S	139:50.65E	2610	154	0418	64:49.26S	139:50.64E	2610	-	0424	64:49.24S	139:50.62E	2610
63 SR3	0444	15-JAN-94	64:49.16S	139:50.61E	2610	2586	0540	64:49.07S	139:50.99E	2610	8.4	0654	64:49.01S	139:51.63E	2620
64 SR3	0849	15-JAN-94	65:04.98S	139:50.91E	2766	2766	1001	65:04.65S	139:50.93E	2693	8.8	1114	65:04.39S	139:50.99E	2558
65 SR3	1354	15-JAN-94	65:24.14S	139:50.91E	2455	2438	1456	65:24.05S	139:51.15E	-	11.0	1558	65:24.01S	139:51.20E	2455
66 SR3	1711	15-JAN-94	65:26.00S	139:51.07E	1854	1936	1811	65:25.98S	139:51.21E	1823	7.5	1914	65:25.86S	139:51.54E	1792
67 SR3	0151	16-JAN-94	65:31.84S	139:51.13E	1274	1264	0229	65:31.74S	139:50.97E	1280	9.0	0319	65:31.66S	139:50.62E	1305
68 SR3	0443	16-JAN-94	65:34.09S	139:50.66E	866	880	0510	65:34.05S	139:50.76E	889	6.9	0549	65:34.05S	139:50.86E	892
69 SR3	0731	16-JAN-94	65:42.49S	139:51.13E	307	294	0744	65:42.42S	139:50.88E	309	8.0	0812	65:42.15S	139:50.55E	320
70 SR3	0916	16-JAN-94	65:48.39S	139:51.04E	220	206	0927	65:48.35S	139:51.02E	221	8.6	0950	65:48.24S	139:50.86E	221
71 SR3	1705	16-JAN-94	66:27.27S	140:12.29E	1082	998	1745	66:27.51S	140:11.81E	994	10.8	1816	66:27.64S	140:11.61E	1004
72 SR3	1953	16-JAN-94	66:22.91S	140:21.73E	824	734	2025	66:22.72S	140:21.53E	761	11.1	2051	66:22.60S	140:21.66E	751

station number	START					maxP (dbar)	BOTTOM					END			
	time	date	latitude	longitude	depth(m)		time	latitude	longitude	depth(m)	altimeter(m)	time	latitude	longitude	depth(m)
73 SR3	2350	16-JAN-94	66:19.70S	140:28.18E	398	364	0003	66:19.77S	140:28.15E	393	16.1	0024	66:19.87S	140:28.08E	398
74 ULS	1418	21-JAN-94	65:07.37S	107:46.15E	542	518	1439	65:07.36S	107:45.96E	543	13.9	1508	65:07.37S	107:45.73E	543
75 ULS	0000	23-JAN-94	63:18.23S	107:49.63E	3304	3304	0111	63:17.84S	107:49.37E	3304	13.0	0229	63:17.84S	107:49.43E	3304
76 PET	0438	26-JAN-94	66:19.31S	84:43.02E	569	550	0506	66:19.33S	84:42.93E	569	9.0	0532	66:19.44S	84:42.86E	574
77 PET	0802	26-JAN-94	66:08.85S	85:00.54E	563	540	0827	66:08.85S	85:00.41E	564	9.3	0854	66:08.97S	85:00.63E	564
78 PET	1107	26-JAN-94	65:59.22S	85:25.88E	258	242	1115	65:59.25S	85:25.91E	258	7.1	1138	65:59.34S	85:26.07E	258
79 PET	1247	26-JAN-94	65:53.61S	85:24.69E	1253	1284	1330	65:53.85S	85:24.98E	1305	5.8	1420	65:54.04S	85:25.31E	-
80 PET	1520	26-JAN-94	65:49.41S	85:25.37E	1735	1912	1619	65:49.25S	85:26.24E	1787	9.2	1718	65:49.32S	85:26.73E	-
81 PET	1819	26-JAN-94	65:44.83S	85:24.48E	2517	2522	1929	65:44.22S	85:23.72E	2539	9.5	2038	65:43.63S	85:22.98E	2517
82 PET	2207	26-JAN-94	65:32.95S	85:24.67E	2942	2932	2321	65:32.71S	85:24.51E	2947	10.8	0030	65:32.59S	85:24.34E	2900
83 PET	0316	27-JAN-94	65:05.55S	85:18.81E	3107	306	0336	65:05.61S	85:19.15E	-	-	0402	65:05.79S	85:19.52E	3128
84 PET	0452	27-JAN-94	65:05.70S	85:18.87E	3107	3112	0603	65:05.77S	85:19.17E	3123	7.2	0722	65:05.79S	85:19.86E	3159
85 PET	1028	27-JAN-94	64:37.05S	84:59.92E	3612	3624	1154	64:37.49S	85:00.16E	3625	5.1	1309	64:37.96S	84:59.77E	3615
86 PET	1628	27-JAN-94	64:09.81S	84:35.62E	3688	206	1645	64:09.92S	84:35.70E	3688	-	1702	64:10.02S	84:35.65E	3781
87 PET	1748	27-JAN-94	64:10.21S	84:36.00E	3688	3710	1915	64:10.18S	84:37.80E	3693	10.8	2043	64:10.42S	84:38.46E	3693
88 PET	2350	27-JAN-94	63:43.22S	84:08.56E	3729	3736	0116	63:43.19S	84:09.42E	3721	13.1	0244	63:43.09S	84:10.35E	3723
89 PET	0530	28-JAN-94	63:17.42S	83:44.76E	2786	256	0536	63:17.42S	83:44.83E	2797	-	0602	63:17.29S	83:45.34E	2797
90 PET	0646	28-JAN-94	63:17.20S	83:45.12E	2776	2770	0748	63:16.60S	83:45.61E	2766	8.5	0853	63:16.15S	83:46.23E	2745
91 PET	1153	28-JAN-94	62:44.89S	83:28.59E	2507	2496	1303	62:44.63S	83:28.45E	2507	8.7	1414	62:44.43S	83:28.47E	2507
92 PET	1734	28-JAN-94	62:09.89S	83:16.70E	2672	2666	1842	62:10.00S	83:16.93E	2672	16.9	1951	62:10.10S	83:17.20E	2683
93 PET	2209	28-JAN-94	61:48.12S	83:07.39E	2310	2298	2306	61:48.06S	83:07.41E	2320	10.0	0001	61:47.75S	83:07.54E	2320
94 PET	0208	29-JAN-94	61:26.43S	82:58.29E	1833	1850	0314	61:26.68S	82:58.18E	1875	10.0	0412	61:26.70S	82:58.21E	1885
95 PET	0704	29-JAN-94	60:56.51S	82:46.17E	2517	2478	0807	60:56.12S	82:45.80E	2486	9.2	0916	60:55.84S	82:45.87E	2465
96 PET	1200	29-JAN-94	60:26.79S	82:34.45E	1673	1644	1243	60:26.71S	82:34.63E	1662	7.4	1335	60:26.70S	82:35.23E	1709
97 PET	1622	29-JAN-94	59:58.36S	82:22.28E	1647	1624	1715	59:58.27S	82:22.78E	1647	15.8	1754	59:58.14S	82:22.89E	1647
98 PET	2117	29-JAN-94	59:27.43S	82:12.33E	1657	1630	2204	59:27.24S	82:12.73E	1657	10.4	2250	59:27.14S	82:12.88E	1657
99 PET	0143	30-JAN-94	58:57.72S	82:01.64E	1310	1290	0225	58:57.54S	82:02.07E	1315	11.5	0309	58:57.38S	82:02.20E	1315
100 TS	1431	31-JAN-94	63:00.06S	70:59.71E	4014	306	1453	63:00.13S	70:59.07E	4014	-	1522	63:00.21S	70:58.36E	4014
101 TS	1632	31-JAN-94	63:00.01S	70:59.79E	4014	4044	1805	63:00.18S	70:59.66E	4014	1.0	1943	63:00.15S	70:59.79E	4014
102 BPR	1538	23-FEB-94	65:26.04S	139:11.02E	890	952	1630	65:25.68S	139:10.84E	963	15.0	1717	65:25.42S	139:10.05E	1061

Table 3: (continued)

station	sal	do	nut	dic	¹³ C	¹⁸ O	alk	doc	ii	dms	pp	cat	-----biology-----								
													pig	lug	cya	alg	os	fc	coc	pc	flv
47 SR3	1	1	1	0	0	0	0	0	0	0	0	0	1	0	0	1	0	0	1	0	0
48 SR3	1	1	1	1	1	0	0	0	1	0	1	1	1	1	0	0	0	0	0	0	1
49 SR3	1	1	1	1	0	0	0	0	0	1	1	1	1	0	0	1	1	1	0	1	1
50 SR3	1	1	1	1	0	0	0	0	0	0	0	0	0	0	0	0	0	0	0	0	0
51 SR3	1	1	1	0	0	0	0	0	0	1	0	0	1	0	0	0	0	0	1	0	0
52 SR3	1	1	1	1	0	0	0	0	1	0	1	1	1	1	0	1	0	0	0	1	1
53 SR3	1	1	1	1	2	0	0	0	1	0	0	0	0	0	0	0	0	0	0	0	0
54 SR3	1	1	1	0	0	0	0	0	0	1	1	1	1	0	0	1	0	0	1	0	0
55 SR3	1	1	1	1	1	0	0	0	0	0	0	0	1	0	0	1	0	0	0	0	0
56 SR3	1	1	1	0	0	0	0	1	0	1	1	1	1	0	0	1	0	0	0	0	0
57 SR3	0	0	0	0	0	0	0	0	0	0	0	0	0	0	0	0	0	0	0	0	1
58 SR3	1	1	1	1	2	0	0	0	1	0	0	0	1	1	0	1	0	0	0	0	0
59 SR3	1	1	1	0	0	0	0	0	0	1	0	0	1	0	0	1	0	0	1	0	0
60 SR3	1	1	1	1	1	0	0	0	1	1	0	0	1	0	0	1	0	0	0	0	0
61 SR3	1	1	1	0	0	0	0	0	0	1	1	1	1	0	0	1	0	0	0	0	0
62 SR3	0	0	0	0	0	0	0	0	0	0	0	0	0	0	0	0	0	0	0	0	1
63 SR3	1	1	1	1	2	0	0	0	1	1	1	1	1	1	0	0	0	0	0	0	0
64 SR3	1	1	1	0	0	0	0	0	0	1	0	0	1	0	0	1	0	0	0	1	0
65 SR3	1	1	1	1	2	0	0	0	1	0	0	0	1	1	0	0	0	0	0	0	0
66 SR3	1	1	1	0	0	0	0	0	0	1	0	0	1	0	0	1	1	0	0	1	0
67 SR3	1	1	1	1	2	0	0	1	1	0	1	1	1	0	0	1	0	1	0	1	0
68 SR3	1	1	1	0	0	0	0	0	0	1	0	0	1	0	0	1	1	0	0	0	1
69 SR3	1	1	1	1	0	0	0	0	1	1	0	0	0	0	0	0	0	0	0	0	1
70 SR3	1	1	1	1	2	0	0	0	1	0	0	0	1	0	0	1	0	0	0	1	0
71 SR3	1	1	1	1	0	0	0	0	0	0	0	0	1	0	0	1	0	1	0	0	0
72 SR3	1	1	1	0	0	0	0	0	0	0	1	1	1	1	0	1	0	0	0	1	0
73 SR3	1	1	1	0	0	0	0	0	0	1	0	0	1	0	0	1	1	0	0	0	0
74 ULS	1	1	1	0	0	0	0	0	0	0	0	0	0	0	0	0	0	0	0	0	0
75 ULS	1	1	1	0	0	0	0	0	0	0	0	0	0	0	0	0	0	0	0	0	0
76 PET	1	1	1	1	2	1	1	2	1	0	0	0	1	1	0	1	0	0	0	1	1
77 PET	1	1	1	1	0	0	0	0	0	0	0	0	1	0	0	0	0	0	0	1	0
78 PET	1	1	1	1	0	0	0	0	0	0	0	0	1	1	0	0	0	0	0	0	0
79 PET	1	1	1	1	2	1	0	2	0	0	0	0	1	0	0	1	0	0	0	0	0
80 PET	1	1	1	0	0	0	0	0	0	0	0	0	1	1	0	0	0	0	0	1	0
81 PET	1	1	1	1	2	0	0	2	1	0	0	0	1	0	0	1	0	0	0	0	0
82 PET	1	1	1	0	0	0	0	0	0	0	0	0	1	1	0	0	0	0	0	1	0
83 PET	1	1	1	1	2	0	0	2	0	0	0	0	1	1	0	1	0	0	0	1	0
84 PET	1	1	1	1	0	0	0	0	0	0	0	0	0	0	0	0	0	0	0	0	0
85 PET	1	1	1	0	0	0	0	0	0	0	0	0	1	0	0	1	0	0	0	0	0
86 PET	1	1	1	1	0	0	0	2	0	0	0	0	1	1	0	0	0	0	1	1	0
87 PET	1	1	1	1	0	0	0	0	0	0	0	0	0	0	0	0	0	0	0	0	0
88 PET	1	1	1	0	0	0	0	0	1	0	0	0	1	0	0	1	0	0	0	0	0
89 PET	1	1	1	1	2	0	0	2	0	0	0	0	1	1	0	1	0	0	0	0	1
90 PET	1	1	1	1	0	0	0	0	0	0	0	0	0	0	0	0	0	0	0	0	0
91 PET	1	1	1	0	0	0	0	0	0	0	0	0	1	0	0	1	0	0	1	0	0
92 PET	1	1	1	1	2	1	0	2	0	0	0	0	1	0	0	0	0	0	1	1	0
93 PET	1	1	1	0	0	0	0	0	0	0	0	0	1	1	0	1	0	0	0	0	0
94 PET	1	1	1	0	0	0	0	0	0	0	0	0	1	0	0	0	0	0	1	1	0
95 PET	1	1	1	1	2	0	1	2	0	0	0	0	1	1	0	0	0	0	0	0	0
96 PET	1	1	1	0	0	0	0	0	0	0	0	0	1	0	0	1	0	0	0	0	0
97 PET	1	1	1	1	0	1	0	0	1	0	0	0	1	0	0	1	0	0	0	0	0
98 PET	1	1	1	0	0	0	0	0	0	0	0	0	1	1	0	1	0	0	0	0	0
99 PET	1	1	1	1	2	1	0	2	1	0	0	0	1	0	0	1	0	0	0	0	1
100 TS	1	1	1	1	1	0	1	1	0	0	1	1	1	1	0	1	0	0	1	0	0
101 TS	1	1	1	1	1	0	1	1	0	0	0	0	0	0	0	0	0	0	0	0	0
102 BPR	1	1	0	0	0	0	0	0	0	0	0	0	0	0	0	0	0	0	0	0	0

3.3 Additional drifters and moorings deployed/recovered

Two bottom pressure recorders (principal investigators Tom Whitworth, University of Texas, A&M, and Dale Pillsbury, Oregon State University) were deployed near either end of the SR3 section, and a single recorder was recovered from the northern end. An additional two bottom pressure recorders near the southern end of SR3 could not be recovered (Table 4). Two upward looking sonar moorings (Bush, 1994), including current meters, were deployed in the vicinity of Casey (Table 5). Several meteorological buoys were also deployed throughout the cruise - these are not discussed further.

3.4 XBT/XCTD deployments

A total of 16 model T-7 Sippican XBT deployments were made along both the SR3 and PET transects. The data were processed further by CSIRO Division of Oceanography (R. Bailey, pers. comm.). Results are not reported here.

3.5 Principal investigators

The principal investigators for the CTD and water sample measurements are listed in Table 6a. Cruise participants are listed in Table 6b.

Table 4: Bottom pressure recorder moorings. Note that for the instruments not recovered, positions given are where the moorings were located at the indicated time. Recovery attempts were made on 17/01/94, and in late February.

deployment number	deployment/recovery time (UTC)	latitude	longitude	CTD station no.
<i>instruments deployed</i>				
Hobart94	02:07, 02/01/94	44° 07.18'S	146° 13.13'E	4 SR3
Dumont94	03:45, 16/01/94	65° 33.68'S	139° 51.15'E	68 SR3
<i>instruments recovered</i>				
Hobart91a	23:21, 01/01/94	44° 06.70'S	146° 13.08'E	4 SR3
<i>unsuccessful recovery attempts</i>				
Dumont92a	21:00, 15/01/94	65° 25.95'S	139° 11.63'E	102 SR3
Dumont92b	21:00, 15/01/94	65° 25.97'S	139° 11.63'E	102 SR3
Dumont92a & b	24/02/94-25/02/94	7 bottom trawls around site		102 SR3

Table 5: Upward looking sonar (ULS) moorings deployed (including current meters [CM]).

site name	deployment time (UTC)	bottom depth (m)	latitude	longitude	instrument depths (m)	CTD station no.
SONEAR	16:45, 21/01/94	520	65° 07.350'S	107° 46.130'E	170 (ULS) 220 (CM) 420 (CM)	74
SOFAR	04:36, 23/01/94	3260	63° 17.746'S	107° 49.429'E	150 (ULS) 200 (CM)	75

Table 6a: Principal investigators (*=cruise participant) for water sampling programmes.

measurement	name	affiliation
CTD, salinity, O ₂ , nutrients	Steve Rintoul	CSIRO
D.I.C., ¹³ C, ¹⁸ O, alkalinity	*Bronte Tilbrook	CSIRO
primary productivity	John Parslow	CSIRO
biological sampling	Harvey Marchant	Antarctic Division
iodate/iodide	Ed Butler	CSIRO
D.M.S.	Graham Jones	James Cook University
D.O.C.	Tom Trull	Antarctic CRC
flavobacteria	*Sue Dobson	University of Tasmania

Table 6b: Scientific personnel (cruise participants).

name	measurement	affiliation
Nathan Bindoff	CTD	Antarctic CRC
Jeremy Harris	CTD	Antarctic CRC
Ian Knott	CTD, electronics	Antarctic CRC
Dennis Root	BPR's, CTD	Oregon State University
Mark Rosenberg	CTD	Antarctic CRC
Steve Bell	salinity, oxygen, nutrients	Antarctic CRC
Ruth Eriksen	salinity, oxygen, nutrients	Antarctic CRC
Anna Brandao	iodate/iodide, D.I.C.	Antarctic CRC
Roger Dargaville	D.I.C., isotopes, alkalinity	Melbourne University
Mark Pretty	D.I.C., isotopes, alkalinity	CSIRO
Bronte Tilbrook	D.I.C., isotopes, alkalinity	CSIRO
Andrew Broadbent	D.M.S.	James Cook University
Don McKenzie	primary productivity, CTD	CSIRO
Sue Dobson	flavobacteria	University of Tasmania
Naomi Parker	biological sampling	Antarctic CRC
Alison Turnbull	biological sampling	Antarctic Division
David James	ornithology	Royal Australasian Ornithologists Union
Paul Scofield	ornithology	Royal Australasian Ornithologists Union
Clive Rapier	radiometry	Antarctic CRC
Pia Geijssel	krill biology	Antarctic Division
Rob King	krill biology	Antarctic Division
Greg Bush	ULS moorings	Curtin University
Wayne Galbraith	ULS moorings	Curtin University
Gordon Bain	deputy voyage leader, CTD	Antarctic Division
Pamela Brodie	computing	Antarctic Division
Jo Jacka	voyage leader	Antarctic Division
Michael Sexton	doctor	Antarctic Division
Tim Stevenson	computing	Antarctic Division
*Andrew Tabor	gear officer	Antarctic Division
Mark Underwood	electronics	Antarctic Division

* retrieved with trawl gear from Dumont D'Urville

4 FIELD DATA COLLECTION METHODS

4.1 CTD and hydrology measurements

In this section, CTD and hydrology data collection methods are discussed. CTD data processing techniques are referred to in Appendix 2, while hydrology laboratory analysis methods are described in Appendix 3. Preliminary results of the CTD data calibration, along with data quality information, are presented in Section 6.

4.1.1 CTD Instrumentation

A General Oceanics (formerly E.G.&G.) Mark III C (i.e. WOCE upgraded) CTD unit, together with a model 1401 deck unit, were used for CTD measurements (Table 7). The raw data stream was logged by two separate IBM compatible PC's, using the General Oceanics data acquisition software CTDACQ. The duplication of the data logging PC's allowed data to be viewed simultaneously (in real time) as column formatted numbers on one screen, and in graphical format on the other; the second PC also provided a backup log of the data.

Table 7: CTD manufacturer specifications.

parameter	sensor	accuracy	resolution
Pressure	Paine Model 211-36-390-02 1500 ohm bonded titanium strain gauge bridge, tube type	± 1.2 dbar	0.1 dbar
Temperature	Rosemount Model 171 BJ platinum thermometer	± 0.003 °C	0.0005°C
Conductivity	Neil Brown Instruments 4 electrode cell (0.4cm x 0.4cm x 3.0 cm long)	± 0.0003 mS/cm	0.0001 mS/cm
Oxygen	Sensormedics polarographic oxygen sensor	-	-
Altimeter	Benthos Model 2110	$\pm 5\%$	0.1 m
Fluorometer	Sea Tech	-	-
P.A.R. sensor	Li-Cor model LI-192SA underwater quantum sensor	$\pm 5\%$ in air	-

The same CTD unit (serial no. 2568) was used throughout the entire cruise. For the electronic and data stream configuration of the instrument, see Table 8. Two different General Oceanics 24-bottle model 1015 rosette pylons were used during the cruise, together with 10 litre General Oceanics Niskin bottles; several CSIRO manufactured 10 litre Niskin bottles were also used for some casts.

Deep sea reversing thermometers (Gohla-Precision) were used to keep track of CTD temperature sensor performance. In general, two protected thermometers were mounted on the shallowest Niskin bottle, while three thermometers (two protected and one unprotected) were mounted on the second deepest bottle. The manufacturer specified accuracy of the protected thermometers is to within ± 0.01 °C for the main thermometer, and ± 0.1 °C for the auxiliary. Readings can be resolved to the third decimal place for the main on the protected thermometers, and to the second decimal place for auxiliary and unprotected readings.

Table 8: CTD electronic and data stream configuration, and data processing parameters. Note that all parameters are assigned 2 bytes in the raw data stream. For the CTD upcast burst data, the first nstart and the last nend data scans are ignored for calculation of burst statistics; the first jfilt data scans are ignored each time the data lagging recursive filter is restarted. τ_T is the time constant of the temperature sensor. jmin is the minimum number of values required in a 2 dbar pressure bin. All the above constants and calculations are described in detail in Appendix 2.

CTD unit number	serial number	scanning frequency (Hz)	bytes per record	bytes per scan	nstart	nend	jfilt	τ_T (s)	jmin
6	2568	25.00	129	25	7	4	13	0.205	10

Scan byte layout: synch. byte, pressure, temperature, conductivity, fast temperature, utility byte, altimeter, pressure temperature, oxygen current, oxygen temperature, fluorescence, photosynthetically active radiation (P.A.R.), end bytes

4.1.2 CTD instrument calibrations

Complete calibration information for the CTD pressure, platinum temperature and pressure temperature sensors are presented in Appendix 1. Formulae used for parameter calculations are presented in Appendix 2. Pre and post cruise calibrations were available for the pressure sensor, the former supplied by the manufacturer, the latter done at the CSIRO Division of Oceanography Calibration Facility. The post cruise CSIRO pressure sensor calibration was used for the cruise data. This calibration was performed using a Budenberg Deadweight Tester (accurate to $\pm 0.05\%$ of the pressure being measured) over the range 0 to 6203 dbar. The titanium strain gauge pressure sensors used in the Mark IIIC CTD's display reduced hysteresis effect compared to the older stainless steel type pressure sensors (Millard et al., 1993). Calibration points from the increasing pressure only were used to produce a single third order fit for pressure (Appendix 1).

Pre and post cruise calibrations were also available for the platinum temperature sensor, as for the pressure sensor. However, a significant change was noted between the two temperature calibrations. In particular, a shift of -0.407°C was noted in the post cruise temperature offset relative to pre cruise value. Comparison of cruise CTD temperature data with reversing thermometer readings (Figure 2a) confirmed that the pre cruise calibration (supplied by the manufacturer) was applicable to the entire cruise. Later testing of the instrument indicated that the post cruise temperature calibration was faulty, thus the pre cruise calibration was used.

A pre cruise manufacturer supplied calibration of the pressure temperature sensor was used for the cruise data. Note that readings from this sensor are applied in a correction formula to pressure data (Appendix 2).

CTD conductivity measurements were calibrated from the in situ salinity samples collected at each station. As a rule, this enables CTD salinity values to be calculated to a much higher accuracy than by the bulk application of a single set of laboratory determined calibration coefficients. Thus there are no laboratory calibrations for the conductivity sensor. Checks were made prior to the cruise to ensure the conductivity sensor was functioning correctly. Similarly, CTD dissolved oxygen measurements were calibrated from the in situ dissolved oxygen samples. The complete conductivity and oxygen in situ calibrations are presented in a later section.

Manufacturer supplied calibrations were applied to the fluorescence and p.a.r. data (Appendix 1). These calibrations are not expected to be correct - correct scaling of fluorescence and p.a.r. data awaits linkage with primary productivity and Seacat (section 3.2) data.

4.1.3 CTD and hydrology data collection techniques

When on deck, the rosette package was housed in a closed laboratory space. Thus all samples were drawn "indoors". The package was deployed through an outward opening hatch, which doubles as a gantry, and was lowered/raised at the following speeds:

0 to 500 m depth - 20 m/min

500 to 1000 m depth - 40 m/min

below 1000 m depth - 60 m/min

Winch speeds were maintained by constantly adjusting the winch wire tension, and thus are approximate average values only. The altimeter output was used to guide the instrument to within 20 m (in most cases) of the bed.

CTD data was logged continuously for the entire down and upcast, while Niskin bottles were fired on the upcast only. At each station, the firing depths for the Niskin bottles were decided on using the graphical output of the CTD downcast data. Typically, the deepest bottle was fired at the bottom of the cast. The rosette package was stopped at each level prior to firing; bottles with reversing thermometers were allowed to equilibrate for 5 min before firing.

A fixed sequence was followed for the drawing of water samples on deck, as follows:

first sample: dissolved oxygen
d.i.c.
¹³C
¹⁸O
alkalinity
productivity
d.o.c.
salinity
nutrients
d.m.s.
iodate/iodide
last sample: biology

(see Table 3 for a summary of which samples were drawn at each station). Reversing thermometers were read after the sampling was complete (or nearing completion), typically within one hour of the raising of the rosette package onto the deck. In between stations, the Niskin bottles were only emptied when resetting the bottles for the next station. This helped prevent the crystallization of salt in o-ring seats and spigots.

4.1.4 Water sampling methods

The methods used for drawing the various water samples from the Niskin bottles are described here. Laboratory analysis techniques are described in later sections.

Dissolved oxygen: sample bottle volume = 300 ml

Bottles are washed and dried before use. As dissolved oxygen samples are drawn first, the Niskin is first tested for obvious leakage by opening the spigot before opening the air valve. Tight fitting silicon tubing is attached to the Niskin spigot for sample drawing. Pickling reagent 1 is 3 M MnCl₂ (2.0 ml used); reagent 2 is 8 N NaOH/4 M NaI (2.0 ml used); reagent 3 is 10 N H₂SO₄ (2.0 ml used).

* start water flow through tube for several seconds, making sure no bubbles remain in tube

* pinch off flow in tube, and insert into bottom of sample bottle

* let flow commence slowly into bottle, gradually increasing by releasing tubing, at all times ensuring no bubbles enter the sample and that turbulence is kept to a minimum

- * fill bottle, overflow by at least one full volume
- * pinch off tube and slowly remove so that bottle remains full to the brim, then rinse glass stopper
- * immediately pickle with reagents 1 then 2, inserting reagent dispenser at least 1 cm below water surface
- * insert glass stopper, ensuring no bubbles are trapped in sample
- * thoroughly shake sample (at least 30 vigorous inversions)
- * store samples in the dark until analysis
- * acidify samples with reagent 3 immediately prior to analysis

Dissolved inorganic carbon: sample bottle volume = 250 ml

Tight fitting silicon tubing is attached to the Niskin spigot for sample drawing. Samples are poisoned with 100 μ l of a saturated solution of $HgCl_2$.

- * drain remaining old sample from the bottle
- * start water flow through tube for several seconds, making sure no bubbles remain in tube
- * insert tube into bottom of inverted sample bottle, allowing water to flush bottle for several seconds
- * pinch off flow in tube, and invert sample bottle to upright position, keeping tube in bottom of bottle
- * let flow commence slowly into bottle, gradually increasing, at all times ensuring no bubbles enter the sample
- * fill bottle, overflow by one full volume, and rinse cap
- * shake a small amount of water from top, so that water level is between threads and bottle shoulder
- * insert tip of poison dispenser just into sample, and poison
- * screw on cap, and invert bottle several times to allow poison to disperse through sample

Salinity: sample bottle volume = 300 ml

- * drain remaining old sample from the bottle (bottles are always stored approximately 1/3 full with water between stations)
 - * rinse bottle and cap 3 times with 100 ml of sample (shaking thoroughly each time); on each rinse, contents of sample bottle are poured over the Niskin bottle spigot
 - * fill bottle with sample, to bottle shoulder, and screw cap on firmly
- At all filling stages, care is taken not to let the Niskin bottle spigot touch the sample bottle.

Nutrients: sample tube volume = 12 ml

Two nutrient sample tubes are filled simultaneously at each Niskin bottle.

- * rinse tubes and caps 3 times
 - * fill tubes
 - * shake out water from tubes so that water level is at or below marking line 2 cm below top of tubes (10 ml mark), and screw on caps firmly
- After sampling, one set of tubes are refrigerated for analysis within 12 hours; the duplicate set of tubes are placed in a freezer until required.

Carbon Isotopes: These are sampled and poisoned in the same fashion as dissolved inorganic carbon, except that 500 ml glass stoppered vacuum flasks are used, and vacuum grease is placed around the stopper before inserting.

Iodate: same as for nutrients

Iodide: same as for nutrients, except 100 ml plastic bottle used.

DMS and DMSP: Sample containers are quickly rinsed, then filled. For shallow samples only, a 750 ml amber glass bottle are used. For full profile sampling, 250 ml polyethylene screwcap jars are used. Subsamples (acidified with 1 ml of concentrated HCl) are taken in the laboratory for DMS and DMSP analysis.

Dissolved organic carbon: Sample jar volume = 250 ml (jars baked for 12 hours at 550°C) During d.o.c. sampling, polyethylene gloves were worn by the sampler. The gloves were changed every second sample.

- * clean spigot with lint free tissue sprayed with acetone
- * rinse spigot copiously with sample water
- * rinse sample jar twice

* fill jar with ~200 ml and screw cap on tightly
After sampling, the jars are stored in the dark in a freezer at -18°C.

Alkalinity: same as for d.i.c. samples, except 500 ml bottle used.

¹⁸O: Sample bottle volume = 20 ml
Sample bottles given 3 quick rinses, then filled.

4.2 Underway measurements

Throughout the cruise, the ship's data logging system continuously recorded bottom depth, ship's position and motion, surface water properties and meteorological information. All measurements were quality controlled during the cruise, to remove bad data (Ryan, 1995).

After quality controlling of the automatically logged GPS data set, gaps (due to missing data and data flagged as bad) are automatically filled by dead-reckoned positions (using the ship's speed and heading). Positions used for CTD stations are derived from this final GPS data set. Bottom depth is measured by a Simrad EA200 12 kHz echo sounder. A sound speed of 1498 ms⁻¹ is used for all depth calculations, and the ship's draught of 7.3 m has been accounted for in final depth values (i.e. depths are values from the surface).

Seawater is pumped on board via an inlet at 7 m below the surface. A portion of this water is diverted to the thermosalinograph (Applied Microsystems Ltd, model STD-12), and to the fluorometer (Turner Design, peak sensitivity for chlorophyll-a). Sea surface temperatures are measured by a sensor next to the seawater inlet at 7 m depth.

The underway measurements for the cruise are contained in column formatted ascii files (Appendix 4). The two file types are as follows (see Appendix 4 for a complete description):

- (i) 10 second digitised underway measurement data, including time, latitude, longitude, depth and sea surface temperature;
- (ii) 15 minute averaged data, including time, latitude and longitude, air pressure, wind speed and direction, air temperature, humidity, quantum radiation, ship speed and heading, roll and pitch, sea surface salinity and temperature, average fluorescence, and seawater flow.

5 MAJOR PROBLEMS ENCOUNTERED

The most serious problem on the cruise was failure to recover either of the two bottom pressure recorder moorings near the southern end of the SR3 section (Table 4). The site was visited initially on 15th January 1994 - no recovery attempt was made at this time due to the 70% sea ice cover. The ship returned to the site on 17th January. Distance ranges were easily obtained from the acoustic releases on each of the two moorings; however, neither mooring would release from the bottom. A final recovery attempt was made when the ship returned to the site in late February with bottom trawling gear. Seven unsuccessful trawl attempts were made, then the ship returned to Hobart.

Problems with some of the CTD and laboratory equipment resulted in some data loss and/or compromise to data quality. The most significant of these problems was failure of all three YeoKal Mk IV salinometers used for the analysis of salinity samples. The first salinometer developed a large drift and was difficult to standardise. The replacement salinometers proved faulty, and were unusable. A significant number of salinity samples were analysed before the problem was fully appreciated, and as a result, the bottle salinity data for stations 69 to 86 are considered unusable. All salinity samples following station 86 were retained for analysis back in port.

The two CTD logging PC's crashed on numerous occasions. In most cases, this occurred while the instruments were still on deck, thus no data was lost. On one occasion however (station 2), the

PC's crashed during the upcast, resulting in loss of the entire downcast CTD data, and half of the upcast CTD burst data.

The Antarctic CRC-owned rosette pylon developed problems early in the cruise, misfiring on many occasions, resulting in missed bottles. The unit was replaced with the spare pylon following station 15. The original pylon was refurbished and reinstalled for station 75 onwards, and performed well for the remainder of the cruise.

Comparison of CTD temperature data with reversing thermometer measurements (Figure 2a) revealed a problem with the CTD temperature sensor calibration for sub-zero water temperatures, most noticeable for stations 61 to 82. Sensor output appears to deviate significantly from a linear response at these lower temperatures, resulting in temperature offsets of the order 0.02°C from the expected calibrated values. This is discussed further in section 6.

6 RESULTS

This section details information relevant to the creation and the quality of the final CTD and hydrology data set. For actual use of the data, the following is important:

CTD data - Tables 16, 17 and 18, and section 6.1.2;

hydrology data - Tables 21 and 22.

Historical data comparisons are made in Appendix 6.

6.1 CTD measurements

6.1.1 Creation of CTD 2 dbar-averaged and upcast burst data

Information relevant to the creation of the calibrated CTD 2 dbar-averaged and upcast burst data is tabulated, as follows:

- * Surface pressure offsets calculated for each station (Appendix 2, section A2.6.1) are listed in Table 11.
- * Missing 2 dbar data averages are listed in Table 12.
- * CTD conductivity calibration coefficients, including the station groupings used for the conductivity calibration, are listed in Tables 13 and 14.
- * CTD raw data scans flagged for special treatment (Appendix 2, section A2.11.1) are listed in Table 15.
- * Suspect 2 dbar averages are listed in Tables 16 and 17. Table 18 lists 2 dbar averages which are linear interpolations of the surrounding 2 dbar averages.
- * CTD dissolved oxygen calibration coefficients are listed in Table 19. The starting values used for the coefficients prior to iteration, and the coefficients varied during the iteration, are listed in Table 20.
- * Upcast CTD burst data automatically flagged with the code -1 (rejected for conductivity calibration) or 0 (questionable value, but still used for conductivity calibration) (see Appendix 2, section A2.7.4) are listed in Appendix 5, Table A5.1.
- * Stations containing fluorescence and photosynthetically active radiation data are listed in Appendix 5, Table A5.3.

* The different protected and unprotected thermometers used for the stations are listed in Appendix 5, Table A5.4.

6.1.2 CTD data quality

The final calibration results for conductivity/salinity and dissolved oxygen, along with the performance check for temperature, are plotted in Figures 2 to 5. For temperature, salinity and dissolved oxygen, the respective residuals ($T_{\text{therm}} - T_{\text{cal}}$), ($s_{\text{btl}} - s_{\text{cal}}$) and ($o_{\text{btl}} - o_{\text{cal}}$) are plotted. For conductivity, the ratio $c_{\text{btl}}/c_{\text{cal}}$ is plotted. T_{therm} and T_{cal} are respectively the protected thermometer and calibrated upcast CTD burst temperature values; s_{btl} , s_{cal} , o_{btl} , o_{cal} , c_{btl} and c_{cal} , and the mean and standard deviation values in Figures 2 to 5, are as defined in Appendix 2.

CTD data quality cautions for the various parameters are discussed below. Table 9 contains a summary of these cautions.

Pressure

The titanium strain gauge pressure sensors used in the Mark IIIC CTD's display a higher noise level than the older stainless steel strain gauge models, with an rms of $\sim\pm 0.2$ dbar (Millard et al., 1993). A small error is therefore introduced to the surface pressure offset values, noting that the offsets are derived by taking spot values from the pressure record (Appendix 2, section A2.6.1). For stations 95 and 96 in particular, offset values fell on small pressure spikes, thus the final surface pressure offsets were estimated from a manual inspection of the pressure data. Note that any noise in the pressure signal is ultimately removed by the 2 dbar-averaging.

The surface pressure offset values for stations 2, 7, 9, 10, 70 and 88 were estimated from the surrounding stations (Table 11). Any resulting additional error in the CTD pressure data is judged to be small (no more than 0.2 dbar).

For the additional digital channels (including pressure temperature, oxygen current, oxygen temperature, fluorescence and photosynthetically active radiation) on the Mark III CTD's, a problem with one digital channel generally transfers to the other digital channels. Thus for stations 6, 8, 9 and 10, flooding of the dissolved oxygen sensor with seawater resulted in bad oxygen current data, which in turn resulted in bad data (Table 12) for the other digital channels, including pressure temperature. To allow accurate calculation of pressure in dbar (Appendix 2), pressure temperature data from station 12 were used in pressure calculations for stations 6, 8, 9 and 10, as follows:

station 6: station 12 pressure temperature data used for entire downcast, and for upcast burst data;
station 8: station 12 pressure temperature data used for $25 \leq p \leq 65$ and $p > 1355$ for downcast, and for all upcast burst data (where pressure p and all numerical values are in dbar);
station 9: station 12 pressure temperature data used for entire downcast and for upcast burst data;
station 10: station 12 pressure temperature data used for entire downcast and for upcast burst data.

Note that the pressure temperature profile for station 12 provides the closest match to the assumed pressure temperature profiles for stations 6, 8, 9 and 10. From Millard et al. (1993), a pressure temperature error of 0.1°C produces a maximum pressure error of less than 0.05 dbar. Thus any resulting error in pressure data for these stations is judged to be small (< 0.3 dbar).

Salinity

The conductivity ratios for all bottle samples are plotted in Figure 3, while the salinity residuals are plotted in Figure 4. The final standard deviation values for the salinity residuals (Figure 4) indicate the CTD salinity data is accurate to within ± 0.002 psu, except for stations 69 to 86 and station 1 (as discussed below).

Station 1 was a test cast, with all bottles fired at a single depth. The calibration of station 1 conductivity uses salinity samples from this single depth only, thus CTD salinity for this station can only be considered accurate to ~ 0.01 psu.

No bottle samples were taken for the shallow casts at stations 18, 27, 35, 57 and 62. These stations are grouped with surrounding stations for conductivity calibration (Table 13).

No salinity bottle data was available for stations 69 to 86 due to salinometer problems, as discussed in section 5. For calibration of CTD conductivity from salinity bottle data (Appendix 2), stations 69 to 73 were grouped with the calibration of stations 64 to 68, while stations 74 to 86 were grouped with the calibration of stations 87 to 88 (Table 13). An appreciable variation in conductivity cell response is likely to have occurred over such a large span of stations. Therefore as no in situ conductivity calibrations were possible for stations 69 to 86, CTD salinity data for these stations can only be regarded as accurate to, at best, 0.005 psu.

For station 64, analysis results were bad for salinity samples from rosette positions 15 to 22. These bottles were rejected for the conductivity calibration.

For station 101, the conductivity sensor was fouled for the entire upcast. All upcast burst data was rejected for the conductivity calibration, and the station was grouped with the calibrations applied to stations 100 and 102 (Table 13).

Temperature

The temperature residuals are shown in Figure 2a, along with the mean offset and standard deviation of the residuals. The thermometer value used in each case is the mean of the two protected thermometer readings (protected thermometers used are listed in Appendix 5, Table A5.4). Note that in the figures, the “dubious” and “rejected” categories refer to corresponding bottle samples and upcast CTD bursts in the conductivity calibration.

As discussed in section 5, a temperature calibration problem exists for sub-zero water temperatures, most significant for stations 61 to 82 (Figure 2b). For these stations, accuracy of the CTD temperature data is diminished to 0.02°C .

Dissolved Oxygen

The dissolved oxygen residuals are plotted in Figure 5. The final standard deviation values are within 1% of full scale values (where full scale is approximately equal to $250\ \mu\text{mol/l}$ for pressure > 750 dbar, and $350\ \mu\text{mol/l}$ for pressure < 750 dbar).

In general, good calibrations of the CTD dissolved oxygen data were obtained using the in situ bottle data, however some atypical values were found for the calibration coefficients (Tables 19 and 20) (see Appendix 2 for full details of calibration formulae). For most stations, the best calibration was achieved using large values of the order 6.0 for the coefficient K_1 (i.e. oxygen current slope), and large negative values of the order -0.7 for the coefficient K_3 (i.e. oxygen current bias). This, however, is not considered relevant to actual data quality. The approximate magnitude of K_1 and K_3 values is sensitive to the oxygen current and oxygen temperature values as determined by eqns A2.9 and A2.10 (Appendix 2): these initial oxygen current and oxygen temperature values are in approximate engineering units only, as there is typically no laboratory calibration of individual oxygen sensors.

In addition, the following unusual coefficient values were found (for typical values, see Millard and Yang, 1993, and Millard, 1991):

station 7: $K_6 < 0$ (usually expect a positive value);
station 11: $K_5 > 1$ (usually expect $0 < K_5 < 1$);
station 12: $K_5 > 1$ (usually expect $0 < K_5 < 1$);
station 39: $K_5 > 1$ (usually expect $0 < K_5 < 1$);
station 49: $K_6 < 0$ (usually expect a positive value);
station 50: $K_5 > 1$ (usually expect $0 < K_5 < 1$);
station 69: $K_4 > 0$ (usually expect a negative value);
station 76: $K_5 > 1$ (usually expect $0 < K_5 < 1$).

Despite some atypical calibration coefficient values, all dissolved oxygen calibrations are considered valid.

CTD dissolved oxygen data from station 1 was unusable due to a defective sensor. Following replacement, oil drainage from the new sensor resulted in unusable dissolved oxygen data for stations 6, 8, 9 and 10.

No bottle samples were collected for stations 18, 27, 35, 57 and 62. No attempt was made to calibrate the dissolved oxygen data for these stations.

No bottles were available to calibrate the CTD dissolved oxygen data for station 89, due to uncertainty as to which Niskin bottles the dissolved oxygen samples were drawn from.

For locations where both a shallow and deep cast were taken (Table 2), in most cases the dissolved oxygen data calibration was not improved by grouping shallow/deep station pairs in the calibration procedure (Appendix 2). Thus stations were calibrated individually for dissolved oxygen data, with the exception of the station 86-87 grouping (Tables 19 and 20).

Fluorescence and P.A.R. Data

As discussed in section 4 above, fluorescence and p.a.r. are effectively uncalibrated. These data should not be used quantitatively other than for linkage with primary productivity data.

6.2 Hydrology data

Hydrology analytical methods are detailed in Appendix 3.

6.2.1 Hydrology data quality

Quality control information relevant to the hydrology data is tabulated, as follows:

* Questionable dissolved oxygen and nutrient Niskin bottle sample values are listed in Tables 21 and 22 respectively. Note that questionable values are included in the hydrology data file, whereas bad values have been removed.

* Laboratory temperatures at the times of nutrient analyses are listed in Table 23.

* Dissolved oxygen Niskin bottle samples flagged with the code -9 (rejected for CTD dissolved oxygen calibration) (see Appendix 2, section A2.13.3) are listed in Appendix 5, Table A5.2.

Table 9: Summary of cautions to CTD data quality.

station no.	CTD parameter	caution
1	salinity	test cast - all bottles fired at same depth; salinity accuracy reduced
2	pressure	surface pressure offset estimated from surrounding stations
6	pressure	station 12 pressure temperature profile used for pressure calculation
7	pressure	surface pressure offset estimated from surrounding stations
8	pressure	station 12 pressure temperature profile used for pressure calculation for $25 \leq p \leq 65$ and $p > 1355$ for downcast, and for all upcast burst data
9	pressure	surface pressure offset estimated from surrounding stations
9	pressure	station 12 pressure temperature profile used for pressure calculation
10	pressure	surface pressure offset estimated from surrounding stations
10	pressure	station 12 pressure temperature profile used for pressure calculation
18	salinity	CTD conductivity calibrated with bottles from surrounding stations
27	salinity	CTD conductivity calibrated with bottles from surrounding stations
35	salinity	CTD conductivity calibrated with bottles from surrounding stations
57	salinity	CTD conductivity calibrated with bottles from surrounding stations
61 to 82	temperature	temperature accuracy diminished
62	salinity	CTD conductivity calibrated with bottles from surrounding stations
64	salinity	bottles 15 to 22 not used in CTD conductivity calibration
69 to 86	salinity	no salinity bottle samples - CTD conductivity calibrated with bottles from stations 64 to 68 and 87 to 88; salinity accuracy reduced
70	pressure	surface pressure offset estimated from surrounding stations
88	pressure	surface pressure offset estimated from surrounding stations
101	salinity	CTD conductivity calibrated with bottles from surrounding stations
1 to 102	fluorescence/p.a.r.	fluorescence and p.a.r. sensors (where active) are uncalibrated

Nutrients

For the phosphate analyses, it was found that the autoanalyser peak height of a sample which was run immediately after a series of wash solution vials (low nutrient sea water) was suppressed by, on average, 2%. It is suspected that this was due to sorption of the phosphomolybdate complex produced by the presence of phosphate in the sample onto the walls of the instrument tubing, after having been exposed to the cleaning action of the low nutrient sea water wash. This effect is best illustrated by running a series of replicate samples: autoanalyser peak heights gradually increase and stabilise to a constant value as successive replicate samples are analysed. The same effect has also been observed for phosphate analyses using Technicon Autoanalysers (D. Terhell, pers. comm.).

Flushing with sodium hydroxide reduced the severity of the effect, but did not eliminate it. The effect was most noticeable for phosphate analyses from stations 25 onwards. Phosphate samples thus effected (in most cases from rosette positions 12 and 24) were deleted from the hydrology data set. No substantial error was noted for stations 1 to 24, so no phosphate samples were deleted from these stations.

The same suppressed peak height effect was noted for data from the previous cruise (Rosenberg et al., 1995). For future cruises, additional "dummy" samples drawn from the Niskin bottles will be inserted in autoanalyser runs immediately following wash solution vials to artificially mask the suppression effect on subsequent samples. It is expected that the resulting vertical phosphate profiles will appear "neater"; however the method used for phosphate analysis needs to be scrutinised for a more permanent solution to the problem. Note that an alternative phosphate chemistry using hydrazine instead of ascorbic acid as the reductant has been trialed (Gordon et al., 1993), with no apparent improvement.

For all near-surface silicate samples (i.e. above ~200 dbar), the autoanalyser silicate peaks were spiked, causing problems in the automatic peak integration performed by the software DAPA (see Appendix 3). The peaks in question were measured manually using an interactive graphics option

within the DAPA software. The cause of the spikes is unknown - the samples coincided with high levels of diatoms (A. Turnbull, pers. comm.), however filtering of the samples produced no change.

The following notes also apply to the nutrient data:

- * For stations 1 and 2 (test casts), and for station 102, no nutrient samples were collected.
- * For the following stations, nutrient concentrations were derived from manual measurements of autoanalyser peak heights, using the strip chart recordings:

station 67 - nitrate+nitrite data
station 71 - silicate data
station 74 - all nutrient data
station 75 - all nutrient data

6.2.2 Hydrology sample replicates

The accuracy and precision of bottle data are considered relative to the full scale deflection of measurement for nutrients, and relative to the maximum data value for dissolved oxygen (Table 10).

Table 10: Maximum values for dissolved oxygen analyses, and full scale deflection values for nutrient analyses.

dissolved oxygen:	~350 $\mu\text{mol/l}$ for pressure < 750 dbar ~250 $\mu\text{mol/l}$ for pressure > 750 dbar
phosphate:	3.0 $\mu\text{mol/l}$
nitrate+nitrite:	35.0 $\mu\text{mol/l}$
silicate:	140 $\mu\text{mol/l}$

In general, no organised sample replication was carried out, thus the replicate data set discussed here is small. Most replicate data were obtained opportunistically, from multiple fired Niskin bottles taken during bottle test casts, or from depths sampled in both casts of shallow/deep cast pairs. Three types of replicate data were obtained from the hydrology data set, as follows.

Replicate samples drawn from the same Niskin bottle

A series of repeat dissolved oxygen samples were drawn from 4 different Niskin bottles at station 102 (Figure 6a). A standard deviation about the mean of 0.218 $\mu\text{mol/l}$ was found for the sample set of 15 values, representing a precision level of better than 0.1% of full scale. No other data were available for this class of replicates.

Replicate samples drawn from different Niskin bottles tripped at same depth

At several stations, multiple Niskin bottles were fired at a single depth. Salinity samples were drawn from all multiple fired Niskins, while dissolved oxygen samples were drawn from only some. No nutrient samples were drawn for this class of replicates. For each set of Niskin bottles tripped at a single depth, a mean value m_x was calculated for the sample set and the differences $x-m_x$ formed, where x is the salinity or dissolved oxygen bottle value; the standard deviation of all $x-m_x$ values for the replicate data was calculated. Note that 10 samples were rejected from the analysis, as they were drawn from leaking Niskin bottles. Absolute values of the differences $x-m_x$ are shown in Figure 6b. The results are summarised as follows:

parameter	standard deviation of $x - m_x$	number of samples	number of sample groups
salinity	0.0012 psu	51	13
dissolved oxygen	0.199 $\mu\text{mol/l}$	24	11

It is assumed that these precision values would be further reduced if sample groups were drawn from the same Niskin bottle.

Replicate samples drawn from equivalent positions at different stations

For some shallow/deep cast pairs i.e. consecutive shallow and deep stations taken at approximately the same location (Table 2), certain depths were sampled for both casts (in most cases, the shallowest depth only). For all such double sampled positions, sample pairs were formed for each parameter measured. For each sample pair, the quantity $0.5(x_1 - x_2)$ was calculated, where x_1 and x_2 are the two parameter values from the pair; the 0.5 factor is included so that the data are comparable to the other classes of replicate data, where a standard deviation about depth mean values was calculated. A quality control element was introduced by rejecting pairs for which the difference of upcast CTD burst temperatures was $\geq 0.1^\circ\text{C}$ (i.e. 0.5 times the difference $\geq 0.05^\circ\text{C}$). One additional sample pair was rejected due to a leaking Niskin bottle; two salinity sample pairs were also rejected as the samples were analysed during the time of salinometer malfunction (see section 5). The results (Figure 6c) are summarised as follows:

parameter	standard deviation of $0.5(x_1 - x_2)$	number of samples
salinity	0.0029 psu	18
dissolved oxygen	1.966 $\mu\text{mol/l}$	22
phosphate	0.0098 $\mu\text{mol/l}$	14
nitrate+nitrite	0.3854 $\mu\text{mol/l}$	26
silicate	1.5740 $\mu\text{mol/l}$	24

The larger precision values found for this class of replicates is an expected result - significant additional error has been introduced by comparing data from different casts. The locations for cast pairs are often separated by several hundred meters (Table 2), while the common depths sampled for cast pairs are not identical. These factors are increasingly important in regions of significant horizontal gradients in parameter values. In addition, some of the precision values (dissolved oxygen, nitrate+nitrite and silicate) would be significantly improved by the rejection of only one or two outliers (Figure 6c).

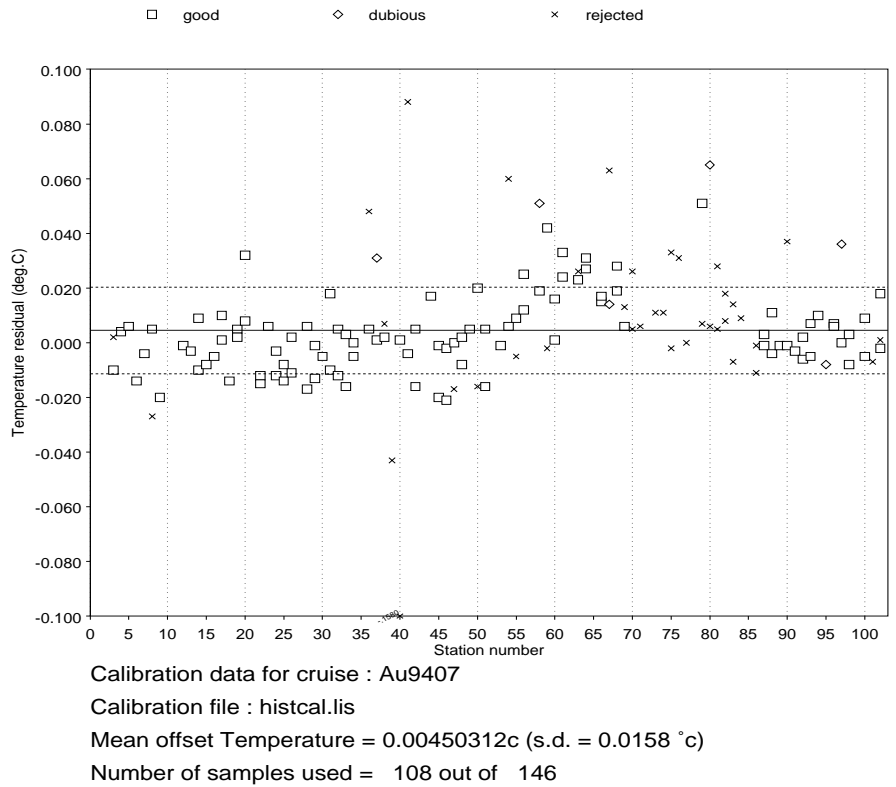

Figure 2a: Temperature residual ($T_{\text{therm}} - T_{\text{cal}}$) versus station number for cruise au9407. The solid line is the mean of all the residuals; the broken lines are \pm the standard deviation of all the residuals (as defined in Appendix 2, section A2.14). Note that the “dubious” and “rejected” categories refer to the conductivity calibration.

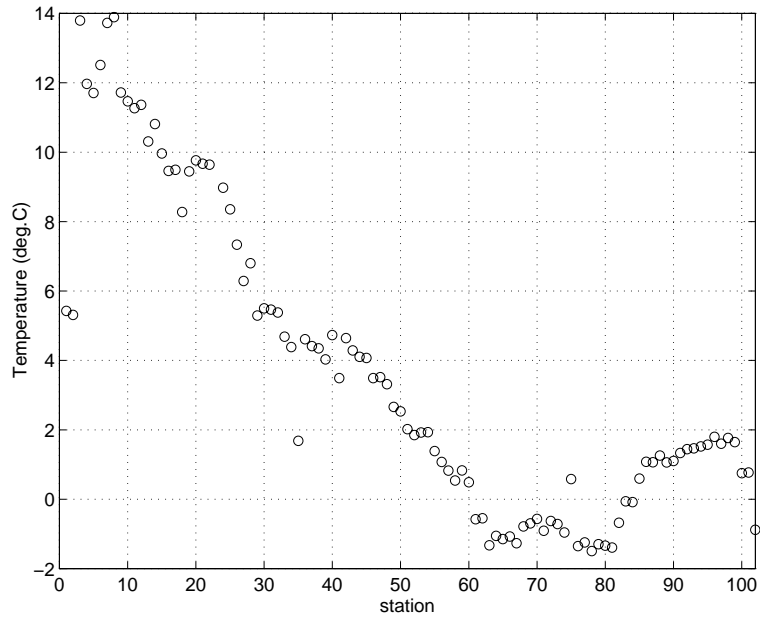
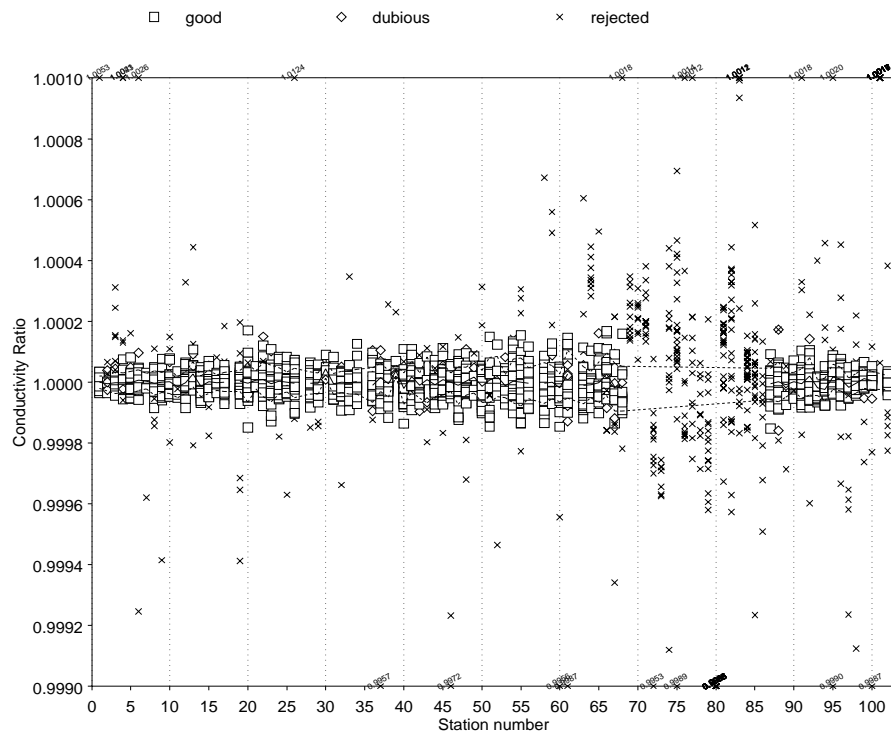

Figure 2b: Water temperature at top Niskin bottle from CTD upcast burst data.



Calibration data for cruise : Au9407
 Calibration file : histcal.lis
 Conductivity s.d. = 0.00005
 Number of bottles used = 1404 out of 1888 Mean ratio for all bottles = 1.00000

Figure 3: Conductivity ratio c_{bt}/c_{cal} versus station number for cruise au9407. The solid line follows the mean of the residuals for each station; the broken lines are \pm the standard deviation of the residuals for each station (as defined in Appendix 2, section A2.14).

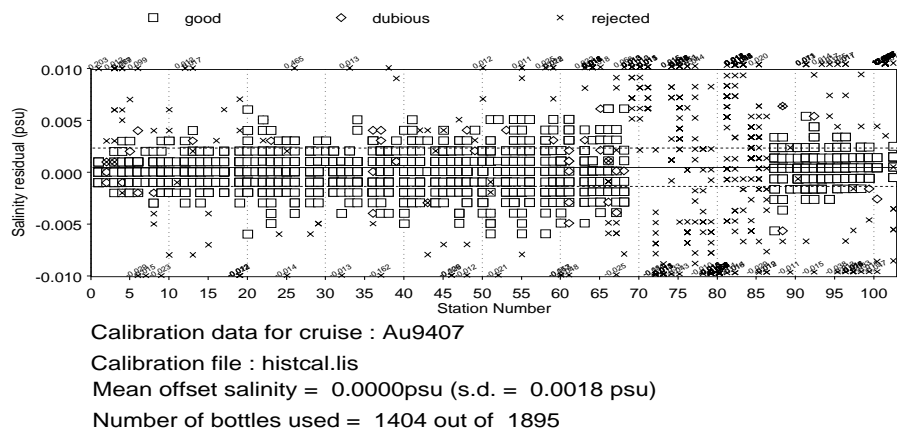

Figure 4: Salinity residual ($s_{btl} - s_{cal}$) versus station number for cruise au9407. The solid line is the mean of all the residuals; the broken lines are \pm the standard deviation of all the residuals (as defined in Appendix 2, section A2.14).

Mean of Residual = 0.008umol/dm**3
 S.D. of residual = 2.952umol/dm**3 (Equiv to 0.066ml/l)
 Used 1646 bottles out of total 1720
 S.D. deep (>750m) 2.239umol/dm**3 (equiv to 0.050ml/l)

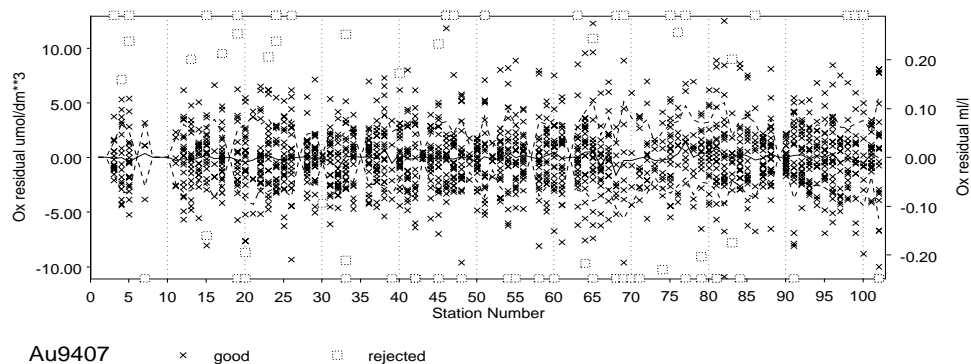
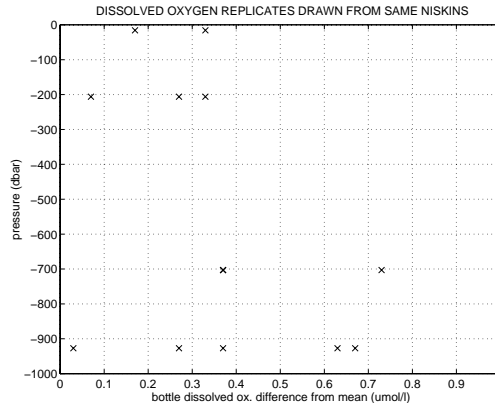
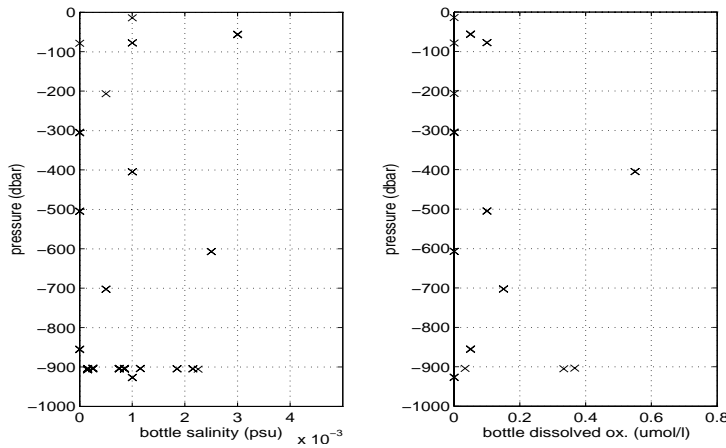

Figure 5: Dissolved oxygen residual ($o_{btl} - o_{cal}$) versus station number for cruise au9407. The solid line follows the mean residual for each station; the broken lines are \pm the standard deviation of the residuals for each station (as defined in Appendix 2, section A2.14).

(a)



(b)



(c)

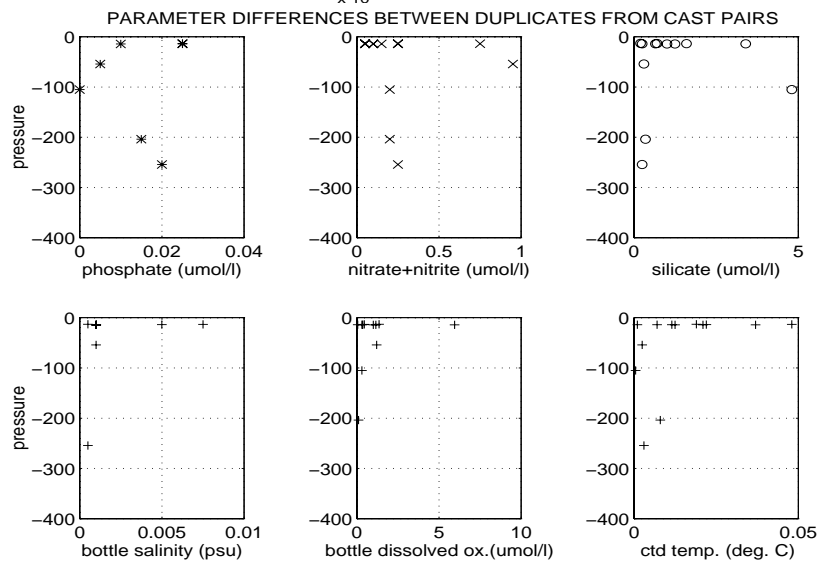

Figure 6: Absolute value of parameter differences for replicate samples, for replicates drawn from (a) the same Niskin bottle, (b) different Niskins tripped at the same depth, and (c) Niskins fired at equivalent positions during different stations. For (a) and (b), differences are between parameter values and depth mean; differences are between sample pairs times 0.5 for (c).

Table 11: Surface pressure offsets (as defined in Appendix 2, section A2.6). ** indicates that value is estimated from surrounding stations, or else determined from manual inspection of pressure data.

station number	surface p offset (dbar)	station number	surface p offset (dbar)	station number	surface p offset (dbar)	station number	surface p offset (dbar)
1 TEST	-1.62	27 SR3	-2.82	53 SR3	-3.55	79 PET	-4.28
2 TEST	-1.62**	28 SR3	-3.23	54 SR3	-3.53	80 PET	-3.50
3 SR3	-1.18	29 SR3	-2.93	55 SR3	-3.63	81 PET	-3.67
4 SR3	-1.34	30 SR3	-2.60	56 SR3	-2.78	82 PET	-3.40
5 SR3	-1.13	31 SR3	-2.81	57 SR3	-3.91	83 PET	-3.27
6 SR3	-1.41	32 SR3	-3.27	58 SR3	-4.57	84 PET	-3.86
7 SR3	-1.41**	33 SR3	-3.03	59 SR3	-3.61	85 PET	-3.78
8 SR3	-1.72	34 SR3	-3.35	60 SR3	-3.71	86 PET	-3.61
9 SR3	-1.73**	35 SR3	-3.14	61 SR3	-4.07	87 PET	-3.63
10 SR3	-1.73**	36 SR3	-3.49	62 SR3	-3.88	88 PET	-3.63**
11 SR3	-1.73	37 SR3	-3.45	63 SR3	-5.02	89 PET	-3.05
12 SR3	-2.44	38 SR3	-3.28	64 SR3	-4.01	90 PET	-3.48
13 SR3	-1.89	39 SR3	-3.26	65 SR3	-3.64	91 PET	-3.17
14 SR3	-1.89	40 SR3	-2.96	66 SR3	-3.94	92 PET	-3.81
15 SR3	-1.92	41 SR3	-2.85	67 SR3	-4.62	93 PET	-3.55
16 SR3	-1.65	42 SR3	-2.66	68 SR3	-3.63	94 PET	-3.71
17 SR3	-1.90	43 SR3	-3.14	69 SR3	-3.66	95 PET	-3.60**
18 SR3	-1.64	44 SR3	-3.12	70 SR3	-3.80**	96 PET	-3.80**
19 SR3	-2.18	45 SR3	-2.89	71 SR3	-3.78	97 PET	-3.68
20 SR3	-1.90	46 SR3	-2.62	72 SR3	-4.27	98 PET	-3.41
21 SR3	-1.91	47 SR3	-3.00	73 SR3	-3.87	99 PET	-3.06
22 SR3	-2.29	48 SR3	-3.30	74 ULS	-3.27	100 TS	-3.66
23 SR3	-2.29	49 SR3	-2.96	75 ULS	-3.38	101 TS	-3.62
24 SR3	-2.68	50 SR3	-3.20	76 PET	-3.76	102 BPR	-2.50
25 SR3	-2.37	51 SR3	-3.31	77 PET	-3.86		
26 SR3	-2.53	52 SR3	-3.08	78 PET	-3.81		

Table 12: Missing data points in 2 dbar-averaged files (i.e. *.all files). “1” indicates missing data for the indicated parameters (T=temperature; S=salinity, σ_T , specific volume anomaly and geopotential anomaly; O=dissolved oxygen; PAR=photosynthetically active radiation; F/PAR=fluorescence and photosynthetically active radiation). Note that jmin is the minimum number of data points required in a 2 dbar bin to form the 2 dbar average (Table 8).

station number	pressures (dbar) where data missing	T	S	O	PAR	F/PAR	reason
1	entire profile			1			bad oxygen sensor
1	62-70, 96-104, 216-218					1	bad digital channel data
1	232-236, 424-426					1	bad digital channel data
1	10, 12, 16			1			bad digital channel data
2	entire profile	1	1	1	1		downcast data lost
3	188 to 212			1			bad oxygen temperature data
6	entire profile			1	1		oil drained from oxygen sensor
8	entire profile			1	1		oil drained from oxygen sensor
9	entire profile			1	1		oil drained from oxygen sensor
10	entire profile			1	1		oil drained from oxygen sensor
18	entire profile			1			no oxygen bottle data for calibration
20	2-56			1			bad oxygen data (deleted)
27	entire profile			1			no oxygen bottle data for calibration
35	entire profile			1			no oxygen bottle data for calibration
37	186-202			1			bad oxygen data (deleted)
48	134-164			1			bad oxygen data (deleted)
49	154			1			bad oxygen data (deleted)
49	156	1	1	1			no. of data pts in 2 dbar bin < jmin
51	62-200			1			bad oxygen data (deleted)
54	1402-1434	1	1	1	1		fouling of conductivity cell
55	274-360			1			bad oxygen data (deleted)
56	2, 12			1			bad oxygen data (deleted)
57	entire profile			1			no oxygen bottle data for calibration
60	54-70			1			bad oxygen data (deleted)
62	entire profile			1			no oxygen bottle data for calibration
65	228-256, 298-320			1			bad oxygen data (deleted)
71	42-72			1			bad oxygen data (deleted)
77	32-76			1			bad oxygen data (deleted)
81	2-24			1			bad oxygen data (deleted)
82	2-30			1			bad oxygen data (deleted)
82	72-112	1	1	1	1		fouling of conductivity cell
89	entire profile			1			no oxygen bottle data for calibration
102	2-12	1	1	1			bad data (deleted 2-10)

Table 13: CTD conductivity calibration coefficients. F_1 , F_2 and F_3 are respectively conductivity bias, slope and station-dependent correction calibration terms. n is the number of samples retained for calibration in each station grouping; σ is the standard deviation of the conductivity residual for the n samples in the station grouping (eqn A2.19).

station grouping	F_1	F_2	F_3	n	σ
001 to 002 SR3	0.36218645E-02	0.96061420E-03	-0.26311155E-06	27	0.000586
003 to 004 SR3	-0.79432793E-02	0.96056305E-03	-0.25317777E-07	26	0.001233
005 to 006 SR3	-0.22839899E-01	0.96087041E-03	-0.71206286E-08	38	0.001247
007 to 009 SR3	-0.26490370E-01	0.96077609E-03	0.21866512E-07	42	0.001213
010 to 014 SR3	-0.25781659E-01	0.96079196E-03	0.10695138E-07	84	0.001266
015 to 016 SR3	-0.29190034E-01	0.96018556E-03	0.63939699E-07	27	0.001195
017 to 019 SR3	-0.33231401E-01	0.96240143E-03	-0.64696331E-07	40	0.001025
020 to 023 SR3	-0.27351840E-01	0.96051767E-03	0.25721478E-07	74	0.001974
024 to 025 SR3	-0.30299213E-01	0.96067744E-03	0.18476654E-07	42	0.001161
026 to 028 SR3	-0.42514665E-01	0.96120679E-03	0.12865039E-07	45	0.001309
029 to 031 SR3	-0.50353096E-01	0.96279223E-03	-0.31623779E-07	49	0.001088
032 to 033 SR3	-0.45130955E-01	0.95878717E-03	0.87353864E-07	43	0.001058
034 to 038 SR3	-0.26467805E-01	0.96070695E-03	0.10383061E-07	93	0.001443
039 to 043 SR3	-0.40217876E-01	0.96192558E-03	-0.93443880E-08	76	0.001547
044 to 048 SR3	-0.25328764E-01	0.96000326E-03	0.21846514E-07	112	0.001417
049 to 051 SR3	0.59190565E-02	0.96019179E-03	-0.28442240E-08	48	0.001926
052 to 054 SR3	0.26730532E-02	0.95881628E-03	0.25804226E-07	51	0.001744
055 to 056 SR3	-0.69062123E-02	0.95954156E-03	0.17440878E-07	42	0.001954
057 to 059 SR3	-0.11119307	0.96722355E-03	-0.58908391E-07	43	0.001861
060 to 063 SR3	-0.66439878E-02	0.95750857E-03	0.49025023E-07	65	0.001911
064 to 073 SR3	0.21312741E-01	0.95976433E-03	-0.20776732E-08	79	0.001890
074 to 088 PET	0.77402498E-01	0.95470654E-03	0.36176548E-07	43	0.001747
089 to 090 PET	-0.80990196E-02	0.95899591E-03	0.17099928E-07	30	0.000962
091 to 095 PET	0.42051964E-01	0.95938559E-03	-0.45634442E-08	100	0.001398
096 to 099 PET	0.53432623E-01	0.95899046E-03	-0.35852866E-08	60	0.001041
100to102TS/BPR	-0.48512144E-02	0.95829965E-03	0.21607866E-07	25	0.000738

Table 14: Station-dependent-corrected conductivity slope term ($F_2 + F_3 \cdot N$), for station number N, and F_2 and F_3 the conductivity slope and station-dependent correction calibration terms respectively.

station number	($F_2 + F_3 \cdot N$)	station number	($F_2 + F_3 \cdot N$)	station number	($F_2 + F_3 \cdot N$)
1 TEST	0.96035109E-03	35 SR3	0.96107036E-03	69 SR3	0.95962097E-03
2 TEST	0.96008798E-03	36 SR3	0.96108075E-03	70 SR3	0.95961890E-03
3 SR3	0.96048709E-03	37 SR3	0.96109113E-03	71 SR3	0.95961682E-03
4 SR3	0.96046177E-03	38 SR3	0.96110151E-03	72 SR3	0.95961474E-03
5 SR3	0.96083481E-03	39 SR3	0.96156115E-03	73 SR3	0.95961266E-03
6 SR3	0.96082769E-03	40 SR3	0.96155181E-03	74 ULS	0.95738360E-03
7 SR3	0.96092915E-03	41 SR3	0.96154246E-03	75 ULS	0.95741978E-03
8 SR3	0.96095102E-03	42 SR3	0.96153312E-03	76 PET	0.95745596E-03
9 SR3	0.96097289E-03	43 SR3	0.96152377E-03	77 PET	0.95749213E-03
10 SR3	0.96089892E-03	44 SR3	0.96096450E-03	78 PET	0.95752831E-03
11 SR3	0.96090961E-03	45 SR3	0.96098635E-03	79 PET	0.95756449E-03
12 SR3	0.96092031E-03	46 SR3	0.96100820E-03	80 PET	0.95760066E-03
13 SR3	0.96093100E-03	47 SR3	0.96103004E-03	81 PET	0.95763684E-03
14 SR3	0.96094170E-03	48 SR3	0.96105189E-03	82 PET	0.95767302E-03
15 SR3	0.96114466E-03	49 SR3	0.96005242E-03	83 PET	0.95770919E-03
16 SR3	0.96120860E-03	50 SR3	0.96004958E-03	84 PET	0.95774537E-03
17 SR3	0.96130159E-03	51 SR3	0.96004673E-03	85 PET	0.95778155E-03
18 SR3	0.96123689E-03	52 SR3	0.96015810E-03	86 PET	0.95781772E-03
19 SR3	0.96117220E-03	53 SR3	0.96018391E-03	87 PET	0.95785390E-03
20 SR3	0.96103210E-03	54 SR3	0.96020971E-03	88 PET	0.95789008E-03
21 SR3	0.96105782E-03	55 SR3	0.96050081E-03	89 PET	0.96051780E-03
22 SR3	0.96108354E-03	56 SR3	0.96051825E-03	90 PET	0.96053490E-03
23 SR3	0.96110926E-03	57 SR3	0.96386578E-03	91 PET	0.95897032E-03
24 SR3	0.96112088E-03	58 SR3	0.96380687E-03	92 PET	0.95896576E-03
25 SR3	0.96113935E-03	59 SR3	0.96374796E-03	93 PET	0.95896119E-03
26 SR3	0.96154128E-03	60 SR3	0.96045007E-03	94 PET	0.95895663E-03
27 SR3	0.96155415E-03	61 SR3	0.96049909E-03	95 PET	0.95895207E-03
28 SR3	0.96156701E-03	62 SR3	0.96054812E-03	96 PET	0.95864627E-03
29 SR3	0.96187514E-03	63 SR3	0.96059714E-03	97 PET	0.95864269E-03
30 SR3	0.96184352E-03	64 SR3	0.95963136E-03	98 PET	0.95863910E-03
31 SR3	0.96181190E-03	65 SR3	0.95962928E-03	99 PET	0.95863551E-03
32 SR3	0.96158250E-03	66 SR3	0.95962721E-03	100 TS	0.96046044E-03
33 SR3	0.96166985E-03	67 SR3	0.95962513E-03	101 TS	0.96048204E-03
34 SR3	0.96105998E-03	68 SR3	0.95962305E-03	102 BPR	0.96050365E-03

Table 15: CTD raw data scans, mostly in the vicinity of artificial density inversions, flagged for special treatment. Note that the pressure listed is approximate only; possible actions taken are either to ignore the raw data scans for all further calculations, or to apply a linear interpolation over the region of the bad data scans. Causes of bad data, listed in the last column, are detailed in Appendix 2 (section A2.11.1). For the raw scan number ranges, the lowest and highest scans numbers are not included in the ignore or interpolate actions.

station number	approximate pressure (dbar)	raw scan numbers	action taken	reason
1 TEST	16; 54; 54	6675-6688; 9873-9898; 9951-9958	ignore	bad press. temp. data
1 TEST	54; 62; 68	10791-10798; 11889-11896; 11967-11974	ignore	bad press. temp. data
1 TEST	95; 102; 206	13059-13090; 13329-13372; 18657-18688	ignore	bad press. temp. data
1 TEST	209; 214; 215	18849-18874; 19263-19270; 19287-19318	ignore	bad press. temp. data
1 TEST	233; 424	20385-20452; 27864-27931	ignore	bad press. temp. data
7 SR3	0; 1	1225-1250; 1261-1382	ignore	bad press. temp. data
8 SR3	1164	65925-66036	ignore	fouling of cond. cell
26 SR3	812	61152-61281	ignore	fouling of cond. cell
39 SR3	16	2154-2159	ignore	wake effect
49 SR3	155	9707-9884	ignore	wake effect
50 SR3	29	2415-2633	ignore	fouling of cond. cell
54 SR3	1397-1433	73257-74347	ignore	fouling of cond. cell
56 SR3	63	13483-13639	ignore	wake effect
56 SR3	731	50347-50470	ignore	fouling of cond. cell
59 SR3	65; 73	7065-7073; 7425-7431	ignore	fouling of cond. cell
70 SR3	0	1-5000	ignore	seawater in sensor cap
76 PET	72; 93; 97	5789-5791; 7548-7550; 7780-7783	ignore	suspect pressure value
82 PET	70-113	4552-7156	ignore	fouling of cond. cell
87 PET	61	3845-3847	ignore	suspect pressure value
102 BPR	0-50	1838-15394	ignore	preliminary dip to 50 dbar

Table 16: Suspect 2 dbar averages.

station number	suspect 2 dbar values (dbar)		reason
	bad	questionable	
<i>Suspect salinity values</i>			
30 SR3	-	76	salinity spike in steep local gradient
30 SR3	78	-	salinity spike in steep local gradient
31 SR3	-	80	salinity spike in steep local gradient
32 SR3	-	58-62	salinity spike in steep local gradient
33 SR3	-	44-50; 72-74	salinity spike in steep local gradient
34 SR3	-	36	salinity spike in steep local gradient
39 SR3	-	16-20	salinity spike in steep local gradient
40 SR3	-	8; 18-20	salinity spike in steep local gradient
41 SR3	-	14; 104	salinity spike in steep local gradient
42 SR3	-	16	salinity spike in steep local gradient
43 SR3	-	34-40	salinity spike in steep local gradient
44 SR3	-	18	salinity spike in steep local gradient
45 SR3	-	30-34	salinity spike in steep local gradient
56 SR3	-	60	salinity spike in steep local gradient
56 SR3	62	-	salinity spike in steep local gradient
94 PET	-	36	salinity spike in steep local gradient
<i>Suspect dissolved oxygen values</i>			
31 SR3	-	76-282	no nearby oxygen bottles to confirm values

Table 17a: Suspect 2 dbar-averaged data from near the surface (applies to all parameters other than dissolved oxygen, except where noted). Note that for station 102, suspect near surface values have been deleted from the data.

station number	suspect 2 dbar values (dbar)		comment	station number	suspect 2 dbar values (dbar)		comment
	bad	questionable			bad	questionable	
6 SR3	-	2-20	temperature ok	71 SR3	-	2-4	temperature ok
11 SR3	-	2		73 SR3	-	2-4	temperature ok
23 SR3	-	2		74 ULS	-	2-4	temperature ok
26 SR3	-	2		76 PET	2-20		
30 SR3	-	2-4	temperature ok	77 PET	-	2	temperature ok
48 SR3	-	2	temperature ok	78 PET	-	2	temperature ok
49 SR3	-	2		80 PET	-	2	temperature ok
52 SR3	-	2	temperature ok	82 PET	-	2-4	temperature ok
54 SR3	-	2	temperature ok	83 PET	-	2	temperature ok
60 SR3	-	2-4	temperature ok	86 PET	-	2	temperature ok
61 SR3	-	2-4	temperature ok	87 PET	-	2	temperature ok
63 SR3	-	2	temperature ok	91 PET	-	2	temperature ok
64 SR3	-	2-4	temperature ok	98 PET	-	2	temperature ok
66 SR3	-	2	temperature ok	99 PET	-	2	temperature ok
68 SR3	-	2	temperature ok	102 BPR	2-10(deleted)		

Table 17b: Suspect 2 dbar-averaged dissolved oxygen data from near the surface.

station number	suspect dissolved oxygen 2 dbar values (dbar)		station number	suspect dissolved oxygen 2 dbar values (dbar)	
	bad	questionable		bad	questionable
3 SR3	-	2-10	50 SR3	-	2-14
5 SR3	-	2-6	54 SR3	-	2-6
14 SR3	-	2-12	56 SR3	-	4
15 SR3	-	2-10	66 SR3	-	2
17 SR3	-	2-10	67 SR3	-	2
19 SR3	-	2	71 SR3	-	2
21 SR3	-	2-10	72 SR3	-	2
22 SR3	-	2-10	73 SR3	-	2-12
24 SR3	-	2-18	77 PET	-	2-12
26 SR3	-	2-6	86 PET	-	2-12
33 SR3	-	2-6	94 PET	-	2-10
40 SR3	-	2-6	99 PET	-	2-14
41 SR3	-	2-12	100 TS	-	2-18
44 SR3	-	2-10	102 BPR	2-10(deleted)	14-16

Table 18: 2 dbar averages interpolated from surrounding 2 dbar values, for the indicated parameters (T=temperature; S=salinity, σ_T , specific volume anomaly and geopotential anomaly; O=dissolved oxygen; PAR=photosynthetically active radiation; F=fluorescence).

station number	interpolated 2 dbar values (dbar)	parameters interpolated	station number	interpolated 2 dbar values (dbar)	parameters interpolated
1 TEST	102;216;234	T,S,O,PAR,F			
8 SR3	1164-1168	S	60 SR3	3486	T,S,O,PAR
14 SR3	1726	T,S,O,PAR			
23 SR3	1726	T,S,O,PAR	65 SR3	56-58	O
25 SR3	1726	T,S,O,PAR			
26 SR3	812-814	T,S,O,PAR	66 SR3	1726	T,S,O,PAR
28 SR3	3486	T,S,O,PAR			
29 SR3	1726	T,S,O,PAR	71 SR3	288	T,S,O,PAR
31 SR3	1726	T,S,O,PAR			
34 SR3	2158	T,S,O,PAR			
47 SR3	1726	T,S,O,PAR			
48 SR3	3486	T,S,O,PAR			
49 SR3	156	PAR	85 PET	3486	T,S,O,PAR
50 SR3	1126-1130;1134	T,S,O,PAR	87 PET	1726;3266;3486	T,S,O,PAR
51 SR3	2380;3486	T,S,O,PAR	88 PET	1726	T,S,O,PAR
53 SR3	1726;3486;4370	T,S,O,PAR	90 PET	1726	T,S,O,PAR
			92 PET	474	T,S,O,PAR
54 SR3	3486	T,S,O,PAR	93 PET	454-456	T,S,O,PAR
55 SR3	2270	T,S,O,PAR	94 PET	1726	T,S,O,PAR
			101 PET	3222;3486;3838	T,S,O,PAR
56 SR3	732	T,S,O,PAR			
			102 BPR	12	PAR
59 SR3	3486	T,S,O,PAR			

Table 19: CTD dissolved oxygen calibration coefficients. K_1 , K_2 , K_3 , K_4 , K_5 and K_6 are respectively oxygen current slope, oxygen sensor time constant, oxygen current bias, temperature correction term, weighting factor, and pressure correction term. dox is equal to 2.8σ (for σ defined as in eqn A2.24, Appendix 2); n is the number of samples retained for calibration in each station or station grouping.

station number	K_1	K_2	K_3	K_4	K_5	K_6	dox	n
1	-	-	-	-	-	-	-	-
2	-	-	-	-	-	-	-	-
3	4.6380	6.0000	-0.499	-0.35246E-01	0.85692	0.19557E-03	0.09458	15
4	5.7430	6.0000	-0.694	-0.45441E-01	0.63331	0.49313E-04	0.19995	17
5	5.2373	7.0000	-0.662	-0.42852E-01	0.98652	0.16922E-03	0.17248	19
6	-	-	-	-	-	-	-	-
7	4.1457	8.5000	0.089	-0.44330E-01	0.52732	-0.40804E-03	0.18887	4
8	-	-	-	-	-	-	-	-
9	-	-	-	-	-	-	-	-
10	-	-	-	-	-	-	-	-
11	2.3532	8.0000	0.189	-0.33572E-01	1.80280	0.24611E-03	0.13388	6
12	6.1765	9.0000	-0.732	-0.63687E-01	1.07130	0.13644E-03	0.19449	20
13	6.0734	7.0000	-0.754	-0.31820E-01	0.65404	0.14486E-03	0.17334	18
14	5.9180	7.0000	-0.726	-0.28478E-01	0.74514	0.14197E-03	0.13436	21
15	6.5298	7.0000	-0.839	-0.48408E-01	0.85422	0.16013E-03	0.16797	20
16	2.7427	6.0000	0.172	-0.10445E-01	0.82533	0.22646E-05	0.22420	6
17	6.9610	6.0000	-0.903	-0.40488E-01	0.35658	0.14081E-03	0.14863	23
18	-	-	-	-	-	-	-	-
19	6.5143	7.0000	-0.816	-0.40945E-01	0.66320	0.14422E-03	0.17335	21
20	6.0785	8.0000	-0.734	-0.41127E-01	0.99372	0.14462E-03	0.21642	22
21	3.6227	7.0000	0.074	-0.35112E-01	0.53569	0.45722E-03	0.25442	5
22	6.3627	6.0000	-0.800	-0.37144E-01	0.74879	0.15083E-03	0.18242	24
23	4.5865	7.0000	-0.489	-0.20154E-01	0.85461	0.12940E-03	0.20779	21
24	6.7039	6.0000	-0.925	-0.32788E-01	0.10467	0.16169E-03	0.16233	20
25	6.3919	7.0000	-0.843	-0.33998E-01	0.09458	0.14892E-03	0.17711	24
26	6.5035	7.0000	-0.825	-0.43069E-01	0.05608	0.12397E-03	0.22038	23
27	-	-	-	-	-	-	-	-
28	5.3339	8.0000	-0.605	-0.22513E-01	0.96866	0.12891E-03	0.13132	24
29	6.6119	7.0000	-0.824	-0.57820E-01	0.91699	0.13465E-03	0.15826	23
30	3.4514	8.0000	0.015	-0.31230E-01	0.98815	0.11837E-03	0.01867	4
31	6.6362	7.0000	-0.840	-0.41346E-01	0.09029	0.11522E-03	0.17252	23
32	6.3479	7.0000	-0.800	-0.51777E-01	0.79205	0.15087E-03	0.15665	24
33	6.4601	7.0000	-0.787	-0.54719E-01	0.63788	0.11984E-03	0.14759	20
34	6.3667	8.0000	-0.800	-0.46579E-01	0.75000	0.14241E-03	0.14771	24
35	-	-	-	-	-	-	-	-
36	6.4085	8.0000	-0.797	-0.49059E-01	0.68932	0.12963E-03	0.15741	24
37	6.3854	7.0000	-0.794	-0.52244E-01	0.65159	0.13701E-03	0.14836	23
38	6.0999	8.0000	-0.800	-0.14073E-01	0.48763	0.16022E-03	0.21646	24
39	4.5162	8.0000	-0.300	-0.36802E-01	1.85790	0.77629E-03	0.18002	5
40	6.8948	6.0000	-0.848	-0.79608E-01	0.66005	0.11927E-03	0.15073	23
41	6.1060	7.0000	-0.731	-0.39274E-01	0.62488	0.12322E-03	0.19740	24
42	6.1393	8.0000	-0.733	-0.59422E-01	0.20872	0.11615E-03	0.22714	19
43	5.8006	6.0000	-0.689	-0.39875E-01	0.99597	0.51551E-03	0.01830	6
44	6.1588	7.0000	-0.752	-0.35296E-01	0.09952	0.11839E-03	0.13997	23
45	6.3478	7.0000	-0.764	-0.66340E-01	0.33186	0.11850E-03	0.19849	22
46	5.9345	7.0000	-0.669	-0.59129E-01	0.48042	0.10859E-03	0.21122	20
47	5.9509	7.0000	-0.699	-0.39938E-01	0.18616	0.11603E-03	0.14874	23
48	6.2069	9.0000	-0.718	-0.86073E-01	0.38118	0.11437E-03	0.21979	23
49	5.1940	7.0000	-0.445	-0.51910E-01	0.22550	-0.35579E-03	0.07725	6

Table 19: (continued)

50	6.2883	7.0000	-0.763	-0.44615E-01	1.42890	0.14517E-03	0.10690	24
51	6.2979	8.0000	-0.716	-0.10704E+00	0.35117	0.10695E-03	0.23228	20
52	5.9395	8.0000	-0.681	-0.37050E-01	0.91636	0.50784E-03	0.06294	6
53	6.1534	7.0000	-0.759	-0.29688E-01	0.67398	0.13619E-03	0.16369	24
54	4.8639	7.0000	-0.400	-0.10146E+00	0.23846	0.73753E-04	0.24248	21
55	6.3252	8.0000	-0.800	-0.32462E-01	0.61883	0.13900E-03	0.18171	23
56	6.1977	8.0000	-0.800	-0.12419E-01	0.83712	0.15614E-03	0.13539	24
57	-	-	-	-	-	-	-	-
58	6.2700	9.0000	-0.750	-0.49034E-01	0.99695	0.13949E-03	0.21450	23
59	6.4541	7.0000	-0.806	-0.32198E-01	0.64776	0.13141E-03	0.17712	24
60	6.7973	7.0000	-0.898	-0.24175E-01	0.81216	0.15090E-03	0.18743	23
61	6.6318	8.0000	-0.778	-0.77340E-01	0.72495	0.11865E-03	0.20031	24
62	-	-	-	-	-	-	-	-
63	6.3574	7.0000	-0.694	-0.80017E-01	0.73133	0.10015E-03	0.19322	23
64	7.2582	7.0000	-0.832	-0.13165E+00	0.75470	0.10743E-03	0.22842	23
65	6.9347	7.0000	-0.807	-0.11184E+00	0.74299	0.12646E-03	0.28536	21
66	6.4475	8.0000	-0.699	-0.11351E+00	0.57400	0.10346E-03	0.17570	19
67	6.2322	7.0000	-0.526	-0.15564E+00	0.73666	0.92372E-04	0.20346	18
68	4.3597	8.0000	-0.271	-0.59517E-01	0.11228	0.49944E-04	0.18126	10
69	5.0115	8.0000	-0.542	0.16156E+00	0.53560	0.29590E-03	0.33524	9
70	5.2768	8.0000	-0.370	-0.11754E+00	0.76528	0.31268E-03	0.24593	5
71	7.0209	8.0000	-0.748	-0.11598E+00	0.71450	0.11669E-03	0.18306	11
72	6.2069	7.0000	-0.688	-0.10458E+00	0.32446	0.11254E-03	0.21289	12
73	6.7986	8.0000	-0.778	-0.33701E-01	0.98052	0.19701E-03	0.09915	7
74	5.4635	6.0000	-0.389	-0.62671E-01	0.90499	0.30995E-04	0.16128	10
75	6.4537	8.0000	-0.756	-0.35922E-01	0.19910	0.12203E-03	0.19733	22
76	7.1131	8.0000	-0.719	-0.38633E-01	1.44620	0.14820E-03	0.18317	11
77	3.9327	8.0000	-0.138	-0.14997E+00	0.37492	0.75369E-04	0.20512	10
78	5.7709	8.0000	-0.495	-0.75655E-01	0.70279	0.32271E-03	0.21500	9
79	7.2419	7.0000	-0.714	-0.14947E+00	0.73222	0.52000E-04	0.16924	15
80	6.7614	8.0000	-0.712	-0.97309E-01	0.57134	0.73130E-04	0.17648	20
81	8.2262	7.0000	-0.951	-0.14529E+00	0.78983	0.10095E-03	0.24020	22
82	2.5566	8.0000	0.162	-0.12975E+00	0.22082	0.19988E-04	0.30134	23
83	6.4409	7.0000	-0.669	-0.28786E-01	0.76568	0.20110E-03	0.12518	10
84	7.6570	7.0000	-0.846	-0.13857E+00	0.74234	0.10002E-03	0.19037	23
85	6.7930	9.0000	-0.712	-0.92281E-01	0.78289	0.96905E-04	0.22427	22
86-87	6.3847	7.0000	-0.715	-0.51692E-01	0.76584	0.12598E-03	0.13637	32
88	6.6636	8.0000	-0.798	-0.34515E-01	0.04419	0.11580E-03	0.19381	24
89	-	-	-	-	-	-	-	-
90	7.0042	8.0000	-0.871	-0.37846E-01	0.07843	0.12325E-03	0.07300	24
91	6.1781	8.0000	-0.627	-0.91690E-01	0.06101	0.75328E-04	0.24590	23
92	6.9241	7.0000	-0.855	-0.34158E-01	0.29276	0.13071E-03	0.15088	24
93	6.2057	7.0000	-0.707	-0.35806E-01	0.13871	0.11699E-03	0.15338	24
94	7.5742	6.0000	-0.993	-0.35650E-01	0.54185	0.14447E-03	0.17418	18
95	7.0757	6.0000	-0.893	-0.32040E-01	0.80723	0.14461E-03	0.17630	23
96	6.8257	7.0000	-0.831	-0.33619E-01	0.90412	0.12997E-03	0.22452	24
97	6.2544	6.0000	-0.707	-0.38825E-01	0.07702	0.11080E-03	0.20367	17
98	6.2725	6.0000	-0.712	-0.36046E-01	0.34643	0.11232E-03	0.17540	17
99	7.6084	9.0000	-0.972	-0.46474E-01	0.99575	0.14924E-03	0.21023	16
100	6.3074	8.0000	-0.747	-0.44495E-01	0.29023	0.14280E-03	0.24388	10
101	6.8670	8.0000	-0.872	-0.26029E-01	0.87188	0.14902E-03	0.13024	21
102	6.0076	5.0000	-0.548	-0.10098E-01	0.89303	0.30454E-05	0.35115	22

Table 20: Starting values for CTD dissolved oxygen calibration coefficients prior to iteration, and coefficients varied during iteration (sections A2.12.1 and A2.12.3). Note that coefficients not varied during iteration are held constant at the starting value.

station number	K ₁	K ₂	K ₃	K ₄	K ₅	K ₆	coefficients varied
1	-	-	-	-	-	-	-
2	-	-	-	-	-	-	-
3	4.6000	6.0000	-0.500	-0.360E-01	0.750	0.15000E-03	K ₁ K ₃ K ₄ K ₅ K ₆
4	5.7000	6.0000	-0.700	-0.400E-01	0.750	0.15000E-03	K ₁ K ₃ K ₄ K ₅ K ₆
5	5.0500	7.0000	-0.700	-0.360E-01	0.900	0.15000E-03	K ₁ K ₃ K ₄ K ₅ K ₆
6	-	-	-	-	-	-	-
7	4.2500	8.5000	0.020	-0.360E-01	0.700	0.15000E-03	K ₁ K ₃ K ₄ K ₅ K ₆
8	-	-	-	-	-	-	-
9	-	-	-	-	-	-	-
10	-	-	-	-	-	-	-
11	2.3000	8.0000	0.190	-0.400E-01	0.750	0.15000E-03	K ₁ K ₃ K ₄ K ₅ K ₆
12	6.1000	9.0000	-0.750	-0.750E-01	0.900	0.15000E-03	K ₁ K ₃ K ₄ K ₅ K ₆
13	6.5000	7.0000	-0.600	-0.360E-01	0.750	0.15000E-03	K ₁ K ₃ K ₄ K ₅ K ₆
14	5.9000	7.0000	-0.710	-0.360E-01	0.750	0.15000E-03	K ₁ K ₃ K ₄ K ₅ K ₆
15	6.2000	7.0000	-0.850	-0.360E-01	0.750	0.15000E-03	K ₁ K ₃ K ₄ K ₅ K ₆
16	2.6000	6.0000	0.180	-0.110E-01	0.650	0.80000E-03	K ₁ K ₃ K ₄ K ₅ K ₆
17	6.9000	6.0000	-0.900	-0.400E-01	0.750	0.15000E-03	K ₁ K ₃ K ₄ K ₅ K ₆
18	-	-	-	-	-	-	-
19	6.5000	7.0000	-0.800	-0.360E-01	0.750	0.15000E-03	K ₁ K ₃ K ₄ K ₅ K ₆
20	5.9000	8.0000	-0.760	-0.500E-01	0.650	0.15000E-03	K ₁ K ₃ K ₄ K ₅ K ₆
21	3.3300	7.0000	0.000	-0.370E-01	0.750	0.15000E-03	K ₁ K ₃ K ₄ K ₅ K ₆
22	6.3000	6.0000	-0.800	-0.360E-01	0.750	0.15000E-03	K ₁ K ₃ K ₄ K ₅ K ₆
23	4.5000	7.0000	-0.500	-0.360E-01	0.750	0.15000E-03	K ₁ K ₃ K ₄ K ₅ K ₆
24	6.8000	6.0000	-0.920	-0.300E-01	0.900	0.15000E-03	K ₁ K ₃ K ₄ K ₅ K ₆
25	6.2000	7.0000	-0.880	-0.420E-01	0.700	0.15000E-03	K ₁ K ₃ K ₄ K ₅ K ₆
26	6.4000	7.0000	-0.820	-0.360E-01	0.800	0.15000E-03	K ₁ K ₃ K ₄ K ₅ K ₆
27	-	-	-	-	-	-	-
28	5.2000	8.0000	-0.630	-0.360E-01	0.750	0.15000E-03	K ₁ K ₃ K ₄ K ₅ K ₆
29	6.5000	7.0000	-0.810	-0.500E-01	0.750	0.15000E-03	K ₁ K ₃ K ₄ K ₅ K ₆
30	3.4000	8.0000	0.000	-0.360E-01	0.750	0.15000E-03	K ₁ K ₃ K ₄ K ₅ K ₆
31	6.5900	7.0000	-0.810	-0.420E-01	0.950	0.15000E-03	K ₁ K ₃ K ₄ K ₅ K ₆
32	2.2800	7.0000	-0.800	-0.480E-01	0.800	0.15000E-03	K ₁ K ₄ K ₅ K ₆
33	6.4000	7.0000	-0.800	-0.360E-01	0.750	0.15000E-03	K ₁ K ₃ K ₄ K ₅ K ₆
34	6.3000	8.0000	-0.800	-0.400E-01	0.750	0.15000E-03	K ₁ K ₄ K ₆
35	-	-	-	-	-	-	-
36	6.3300	8.0000	-0.800	-0.360E-01	0.750	0.15000E-03	K ₁ K ₃ K ₄ K ₅ K ₆
37	6.3000	7.0000	-0.800	-0.360E-01	0.740	0.15000E-03	K ₁ K ₃ K ₄ K ₅ K ₆
38	6.1500	8.0000	-0.800	-0.360E-01	0.750	0.15000E-03	K ₁ K ₃ K ₄ K ₅ K ₆
39	4.3200	8.0000	-0.400	-0.360E-01	0.950	0.15000E-03	K ₁ K ₃ K ₄ K ₅ K ₆
40	6.8000	6.0000	-0.880	-0.400E-01	0.750	0.15000E-03	K ₁ K ₃ K ₄ K ₅ K ₆
41	5.9000	7.0000	-0.710	-0.370E-01	0.750	0.15000E-03	K ₁ K ₃ K ₄ K ₅ K ₆
42	5.9500	8.0000	-0.720	-0.360E-01	0.200	0.15000E-03	K ₁ K ₃ K ₄ K ₅ K ₆
43	5.8000	6.0000	-0.700	-0.360E-01	0.750	0.15000E-03	K ₁ K ₃ K ₄ K ₅ K ₆
44	6.1000	7.0000	-0.750	-0.360E-01	0.750	0.15000E-03	K ₁ K ₃ K ₄ K ₅ K ₆
45	6.1500	7.0000	-0.800	-0.400E-01	0.750	0.15000E-03	K ₁ K ₃ K ₄ K ₅ K ₆
46	5.8000	7.0000	-0.700	-0.400E-01	0.750	0.15000E-03	K ₁ K ₃ K ₄ K ₅ K ₆
47	5.8200	7.0000	-0.700	-0.380E-01	0.750	0.15000E-03	K ₁ K ₃ K ₄ K ₅ K ₆
48	6.3000	9.0000	-0.780	-0.700E-01	0.600	0.15000E-03	K ₁ K ₃ K ₄ K ₅ K ₆
49	5.1000	7.0000	-0.450	-0.500E-01	0.350	0.10000E-03	K ₁ K ₃ K ₄ K ₅ K ₆
50	6.2000	7.0000	-0.790	-0.500E-01	0.900	0.15000E-03	K ₁ K ₃ K ₄ K ₅ K ₆
51	6.6000	8.0000	-0.700	-0.360E-01	0.750	0.15000E-03	K ₁ K ₃ K ₄ K ₅ K ₆

Table 20: (continued)

52	5.9000	8.0000	-0.700	-0.360E-01	0.750	0.15000E-03	K ₁	K ₃ K ₄ K ₅ K ₆
53	6.1000	7.0000	-0.750	-0.360E-01	0.750	0.15000E-03	K ₁	K ₃ K ₄ K ₅ K ₆
54	4.1000	7.0000	-0.400	-0.360E-01	0.600	0.15000E-03	K ₁	K ₄ K ₅ K ₆
55	6.4000	8.0000	-0.800	-0.360E-01	0.750	0.15000E-03	K ₁	K ₄ K ₅ K ₆
56	6.5000	8.0000	-0.800	-0.360E-01	0.750	0.15000E-03	K ₁	K ₄ K ₅ K ₆
57	-	-	-	-	-	-	-	-
58	6.7000	9.0000	-0.750	-0.110E+00	0.900	0.15000E-03	K ₁	K ₄ K ₅ K ₆
59	6.4000	7.0000	-0.800	-0.360E-01	0.750	0.15000E-03	K ₁	K ₃ K ₄ K ₅ K ₆
60	6.9500	7.0000	-0.850	-0.360E-01	0.750	0.15000E-03	K ₁	K ₃ K ₄ K ₅ K ₆
61	6.5500	8.0000	-0.800	-0.360E-01	0.750	0.15000E-03	K ₁	K ₃ K ₄ K ₅ K ₆
62	-	-	-	-	-	-	-	-
63	6.1500	7.0000	-0.700	-0.360E-01	0.750	0.15000E-03	K ₁	K ₃ K ₄ K ₅ K ₆
64	7.2000	7.0000	-0.890	-0.360E-01	0.750	0.15000E-03	K ₁	K ₃ K ₄ K ₅ K ₆
65	6.9000	7.0000	-0.860	-0.360E-01	0.750	0.15000E-03	K ₁	K ₃ K ₄ K ₅ K ₆
66	5.9700	8.0000	-0.750	-0.420E-01	0.750	0.15000E-03	K ₁	K ₃ K ₄ K ₅ K ₆
67	6.0300	7.0000	-0.580	-0.360E-01	0.750	0.15000E-03	K ₁	K ₃ K ₄ K ₅ K ₆
68	4.1300	8.0000	-0.300	-0.360E-01	0.750	0.15000E-03	K ₁	K ₃ K ₄ K ₅ K ₆
69	4.7400	8.0000	-0.600	-0.360E-01	0.740	0.15000E-03	K ₁	K ₃ K ₄ K ₅ K ₆
70	5.3800	8.0000	-0.400	-0.360E-01	0.750	0.15000E-03	K ₁	K ₃ K ₄ K ₅ K ₆
71	6.7400	8.0000	-0.800	-0.360E-01	0.750	0.15000E-03	K ₁	K ₃ K ₄ K ₅ K ₆
72	5.9600	7.0000	-0.850	-0.360E-01	0.750	0.15000E-03	K ₁	K ₃ K ₄ K ₅ K ₆
73	6.7000	8.0000	-0.820	-0.360E-01	0.660	0.15000E-03	K ₁	K ₃ K ₄ K ₅ K ₆
74	5.5000	6.0000	-0.350	-0.500E-01	0.750	0.15000E-03	K ₁	K ₃ K ₄ K ₅ K ₆
75	6.3900	8.0000	-0.740	-0.360E-01	0.750	0.15000E-03	K ₁	K ₃ K ₄ K ₅ K ₆
76	7.2000	8.0000	-0.700	-0.350E-01	0.750	0.15000E-03	K ₁	K ₃ K ₄ K ₅ K ₆
77	4.0700	8.0000	-0.350	-0.360E-01	0.750	0.15000E-03	K ₁	K ₃ K ₄ K ₅ K ₆
78	5.3600	8.0000	-0.660	-0.360E-01	0.750	0.15000E-03	K ₁	K ₃ K ₄ K ₅ K ₆
79	6.3100	7.0000	-0.750	-0.360E-01	0.750	0.15000E-03	K ₁	K ₃ K ₄ K ₅ K ₆
80	5.7700	8.0000	-0.700	-0.360E-01	0.750	0.15000E-03	K ₁	K ₃ K ₄ K ₅ K ₆
81	6.4800	7.0000	-0.900	-0.360E-01	0.750	0.15000E-03	K ₁	K ₃ K ₄ K ₅ K ₆
82	5.8400	8.0000	-0.790	-0.360E-01	0.750	0.15000E-03	K ₁	K ₃ K ₄ K ₅ K ₆
83	6.4000	7.0000	-0.650	-0.360E-01	0.750	0.15000E-03	K ₁	K ₃ K ₄ K ₅ K ₆
84	7.4000	7.0000	-0.880	-0.360E-01	0.750	0.15000E-03	K ₁	K ₃ K ₄ K ₅ K ₆
85	6.7000	9.0000	-0.750	-0.360E-01	0.770	0.15000E-03	K ₁	K ₃ K ₄ K ₅ K ₆
86-87	6.4000	7.0000	-0.730	-0.360E-01	0.750	0.15000E-03	K ₁	K ₃ K ₄ K ₅ K ₆
88	6.6500	8.0000	-0.800	-0.360E-01	0.750	0.15000E-03	K ₁	K ₃ K ₄ K ₅ K ₆
89	-	-	-	-	-	-	-	-
90	6.9000	8.0000	-0.900	-0.360E-01	0.750	0.15000E-03	K ₁	K ₃ K ₄ K ₅ K ₆
91	6.5000	8.0000	-0.550	-0.400E-01	0.700	0.15000E-03	K ₁	K ₃ K ₄ K ₅ K ₆
92	7.4000	7.0000	-0.730	-0.360E-01	0.750	0.15000E-03	K ₁	K ₃ K ₄ K ₅ K ₆
93	6.3000	7.0000	-0.680	-0.360E-01	0.750	0.15000E-03	K ₁	K ₃ K ₄ K ₅ K ₆
94	7.7000	6.0000	-0.910	-0.360E-01	0.750	0.15000E-03	K ₁	K ₃ K ₄ K ₅ K ₆
95	7.0000	6.0000	-0.900	-0.360E-01	0.750	0.15000E-03	K ₁	K ₃ K ₄ K ₅ K ₆
96	6.7000	7.0000	-0.870	-0.360E-01	0.750	0.15000E-03	K ₁	K ₃ K ₄ K ₅ K ₆
97	6.6000	6.0000	-0.600	-0.360E-01	0.850	0.15000E-03	K ₁	K ₃ K ₄ K ₅ K ₆
98	6.3000	6.0000	-0.700	-0.360E-01	0.750	0.15000E-03	K ₁	K ₃ K ₄ K ₅ K ₆
99	7.7000	9.0000	-0.920	-0.450E-01	0.800	0.15000E-03	K ₁	K ₃ K ₄ K ₅ K ₆
100	6.2000	8.0000	-0.630	-0.400E-01	0.650	0.15000E-03	K ₁	K ₃ K ₄ K ₅ K ₆
101	7.3000	8.0000	-0.750	-0.360E-01	0.750	0.15000E-03	K ₁	K ₃ K ₄ K ₅ K ₆
102	5.8000	5.0000	-0.450	-0.750E-01	0.900	0.20000E-03	K ₁	K ₃ K ₄ K ₅ K ₆

Table 21: Questionable dissolved oxygen Niskin bottle sample values (not deleted from hydrology data file).

station number	rosette position
6 _	16

Table 22: Questionable nutrient sample values (not deleted from hydrology data file).

PHOSPHATE		NITRATE		SILICATE	
station number	rosette position	station	rosette number	station	rosette number
4	23			5	2
6	2			8	8
				10	4
14	8	14	8,9	22	3,8
24	8	24	8	24	4,8
				25	2
31	10	31	10	31	10
				32	4
				37	3
				38	5
41	10	41	10	42	3
				46	1
				54	5,7
		55	9	60	7
				61	4,7
		66	19	66	12,14
		67	6	67	6
		68	5	68	5
		73	3		
75	4	75	4		
		87	4		

Table 23: Laboratory temperatures TI at the times of nutrient analyses, used for conversion to gravimetric units for WOCE format data (Appendix 7). The lower temperatures for stations 6 to 11, and station 16, were due to malfunction of the laboratory air-conditioning system.

stn no.	TI (oC)	stn no.	TI (oC)	stn no.	TI (oC)	stn no.	TI (oC)	stn no.	TI (oC)
1	TEST -	22	SR3 22.5	43	SR3 22.5	64	SR3 22.0	85	PET 23.0
2	TEST -	23	SR3 22.5	44	SR3 23.5	65	SR3 22.0	86	PET 22.0
3	SR3 22.0	24	SR3 21.5	45	SR3 21.0	66	SR3 22.0	87	PET 22.0
4	SR3 22.0	25	SR3 22.5	46	SR3 24.5	67	SR3 22.0	88	PET 22.0
5	SR3 22.0	26	SR3 22.5	47	SR3 22.0	68	SR3 22.0	89	PET 22.0
6	SR3 20.0	27	SR3 -	48	SR3 22.5	69	SR3 22.5	90	PET 22.0
7	SR3 20.0	28	SR3 22.5	49	SR3 23.0	70	SR3 22.5	91	PET 23.0
8	SR3 20.0	29	SR3 22.5	50	SR3 23.0	71	SR3 22.3	92	PET 20.5
9	SR3 18.0	30	SR3 22.5	51	SR3 23.0	72	SR3 22.3	93	PET 22.0
10	SR3 18.0	31	SR3 22.5	52	SR3 23.0	73	SR3 22.3	94	PET 23.5
11	SR3 20.0	32	SR3 22.5	53	SR3 23.0	74	ULS 23.5	95	PET 23.0
12	SR3 22.5	33	SR3 23.5	54	SR3 23.0	75	ULS 23.5	96	PET 23.0
13	SR3 22.5	34	SR3 23.5	55	SR3 23.0	76	PET 20.5	97	PET 23.0
14	SR3 22.5	35	SR3 -	56	SR3 23.0	77	PET 20.5	98	PET 23.0
15	SR3 23.0	36	SR3 24.5	57	SR3 -	78	PET 20.5	99	PET 23.0
16	SR3 20.0	37	SR3 22.5	58	SR3 22.5	79	PET 21.0	100	TS 23.0
17	SR3 24.0	38	SR3 22.0	59	SR3 23.0	80	PET 22.0	101	TS 23.5
18	SR3 -	39	SR3 22.5	60	SR3 23.5	81	PET 22.0	102	BPR -
19	SR3 24.0	40	SR3 20.5	61	SR3 22.5	82	PET 22.0		
20	SR3 23.5	41	SR3 22.5	62	SR3 -	83	PET 22.0		
21	SR3 22.5	42	SR3 23.0	63	SR3 22.5	84	PET 23.0		

ACKNOWLEDGEMENTS

Thanks to all scientific personnel who participated in the cruise, and to the crew of the RSV Aurora Australis. The work was supported by the Department of Environment, Sport and Territories through the CSIRO Climate Change Research Program, the Antarctic Cooperative Research Centre, and the Australian Antarctic Division.

REFERENCES

- Bush, G., 1994. Deployment of upward looking sonar buoys. Centre for Marine Science and Technology, Curtin University of Technology, Western Australia, Report No. C94-4 (unpublished).
- Dickson, B.R., 1993. RRS Discovery Cruise 200: the Deployment Phase of the Antarctic Deep Outflow Experiment (ADOX-I). In Sigma, the UK WOCE Newsletter, Issue No. 10, July 1993 (David Cotton and Louise Fuger editors), James Rennell Centre, Southampton.
- Gordon, L.I., Jennings, J.C. Jr., Ross, A.A., and Krest, J.M., 1993. A Suggested Protocol for Continuous Flow Automated Analysis of Seawater Nutrients (Phosphate, Nitrate, Nitrite and Silicic Acid) in the WOCE Hydrographic Program and the Joint Global Ocean Fluxes Study. Oregon State University College of Oceanic and Atmospheric Sciences, Corvallis, Oregon. Technical Report No. 93-1. 51 pp.
- Millard, R.C., 1991. CTD Oxygen Calibration Procedure - in WOCE Operations Manual, 1991. WHP Office Report WHPO 91-1, WOCE Report No. 68/91, Woods Hole, Mass., USA.
- Millard, R.C. and Yang, K., 1993. CTD calibration and processing methods used at Woods Hole Oceanographic Institution. Woods Hole Oceanographic Institution Technical Report No. 93-44. 96 pp.
- Millard, R., Bond, G. and Toole, J., 1993. Implementation of a titanium strain gauge pressure transducer for CTD applications. Deep-Sea Research I, Vol. 40, No. 5, pp1009-1021.
- Rintoul, S.R. and Bullister, J.L. (in preparation). A late winter section between Tasmania and Antarctica: Circulation, transport and water mass formation.
- Rosenberg, M., Eriksen, R. and Rintoul, S., 1995. Aurora Australis marine science cruise AU9309/AU9391 - oceanographic field measurements and analysis. Antarctic Cooperative Research Centre, Research Report No. 2, March 1995. 103 pp.
- Ryan, T., 1995. Data Quality Manual for the data logged instrumentation aboard the RSV Aurora Australis.. Australian Antarctic Division, unpublished manuscript, second edition, April 1995.
- Speer, K.G. and Forbes, A., 1994. A deep western boundary current in the South Indian Basin. Deep-Sea Research I, Vol. 41, No. 9, pp. 1289-1303.

APPENDIX 1 CTD Instrument Calibrations

Table A1.1: Calibration coefficients and calibration dates for CTD serial number 2568 (unit no. 6) used during RSV Aurora Australis cruise AU9407. Note that an additional pressure bias term due to the station dependent surface pressure offset exists for each station (eqn A2.1, Appendix 2). Also note that platinum temperature calibrations are for the ITS-90 scale.

coefficient	value of coefficient
-------------	----------------------

pressure calibration coefficients (after terminology of eqn A2.1, Appendix 2)

CSIRO Calibration Facility - 13/09/1994

pcal0	-3.825752e+01
pcal1	1.075168e-01
pcal2	-9.623422e-10
pcal3	1.921987e-14

platinum temperature calibration coefficients (after terminology of eqn A2.4, Appendix 2)

General Oceanics - July 1993

Tcal0	2.146878e-01
Tcal1	5.011125e-04
Tcal2	-1.881981e-12

pressure temperature calibration coefficients (after terminology of eqn A2.3, Appendix 2)

General Oceanics - July 1993

Tpcal0	6.059389e+01
Tpcal1	-1.703108e-03
Tpcal2	-3.010541e-09
Tpcal3	0.000000

coefficients for temperature correction to pressure (after terminology of eqn A2.2, Appendix 2)

General Oceanics - July 1993

T ₀	21.65 (laboratory temperature for CSIRO pressure sensor calibration)
S ₁	-3.5198e-06
S ₂	-2.3380e-01

preliminary polynomial coefficients applied to fluorescence (fl) and photosynthetically active radiation (par) raw digitiser counts (supplied by manufacturer)

f0	-2.699918e+01
f1	8.239746e-04
f2	-2.071294e-24
par0	-4.499860e+02
par1	1.373000e-02
par2	-3.452000e-21

APPENDIX 2 CTD and Hydrology Data Processing and Calibration Techniques

ABSTRACT

Complete details are presented of the calibration and data processing techniques used to generate calibrated and quality controlled CTD 2 dbar-averaged data, and hydrology data. Attention is given to the order in which the various calculations and corrections are applied, as any variation will affect the final data values produced.

A2.1 INTRODUCTION

This Appendix details the data processing and calibration techniques employed in the production of the final CTD data set on shore. Logging of the data at sea is discussed in the main text. The different sections in this Appendix, and the description within each section, are ordered to match the steps in the data processing flow. Most of the data processing software is written in FORTRAN.

Data sets for different cruises may vary in the specifications of the CTD (Tables 7 and 8 in the main text), and in the parameters generated. The generality of this description is retained so that it will be applicable to future data sets. Thus, the processing of a CTD raw data stream which includes pressure, temperature, conductivity, pressure temperature, oxygen current, oxygen temperature, and additional digitiser channels (e.g. fluorescence, photosynthetically active radiation, etc.) (Table 8) is detailed here. For future cruise data sets, any variation in the processing and calibration techniques described here will be detailed in the data report attached to the data set.

Changes to calibration techniques from previous cruise

Note that this Appendix is for the most part reproduced from Rosenberg et al. (1995). Several changes to the calibration techniques from the previous cruise have however occurred, and these changes are incorporated into the text and equations of this Appendix. The changes are summarised as follows:

1. Two pressure bias terms are applied in the pressure calibration (eqn A2.1) - the surface pressure offset term p_{off} , which varies for each station; and the pressure offset calibration coefficient $pcal0$, derived from calibration of the pressure sensor (Appendix 1), which applies to the entire cruise (these two terms were previously incorporated into a single station varying coefficient). Calibrated pressure values (including application of the pressure temperature correction) are used in the determination of p_{off} values (section A2.6.1) (uncalibrated pressures were used previously).
2. The same set of pressure calibration coefficients (eqn A2.1) now apply to both downcast and upcast data (section A2.6.2). These coefficients are applied to the pressure in raw digitiser counts.
3. The pressure sensor calibration (eqn A2.1) is no longer to the fifth order (third order only for this cruise).
4. A new correction is made to pressure data for the temperature at the pressure sensor (eqns A2.2 and A2.3).
5. The temperature calibration is now second order (eqn A2.4), and the calibration coefficients are applied to the temperature in raw digitiser counts.
6. In the conductivity cell deformation correction (eqn A2.7), the standard temperature and pressure values subtracted from T and p respectively have new values.

7. The temperature sensor time constant τ_T used in sensor lagging corrections (section A2.7.2) has a value of 0.205 (was set to 0.175 previously).

8. Problems with one of the additional digital channels (e.g. oxygen current) can result in bad pressure temperature data, which in turn yield bad pressure values (section A2.11.1). In such cases, pressure data must be reconstructed using pressure temperature profiles from other stations.

9. In determining an approximate time base for calculation of the oxygen current derivative with respect to time, the denominators in eqn A2.23 have new values (they are set according to the data recording frequency of the CTD).

10. When calculating the variance of the dissolved oxygen residuals ($O_{\text{btl}} - O_{\text{cal}}$) in eqn A2.24, the denominator is now (n-1) (was previously n) - this follows the strict definition of a variance.

A2.2 DATA FILE TYPES

The various data files used throughout the data calibration procedure on shore (and produced by it) are outlined below. A complete description of final calibrated data files is given in Appendix 4.

A2.2.1 CTD data files

Throughout this report, three types of CTD file are referred to:

(i) raw CTD files, which contain the complete CTD data prior to removal of pressure reversals, and prior to averaging; note that a data scan refers to one complete data line containing all the logged parameters - thus the raw data is logged at N data scans per second, where N is the scanning frequency (Table 8);

(ii) intermediate CTD files prior to 2 dbar averaging, despiked and with sensor lags applied, and with pressure reversals removed for downcast data;

(iii) 2 dbar-averaged CTD files, which contain the CTD data averaged over 2 dbar bins.

The CTD filenames are of the form vyyccuss.xxx:n (e.g. a94076046.raw:1) where

v = vessel (e.g. "a" for Aurora Australis)
yy = year (e.g. 94)
cc = cruise number (e.g. 07)
u = CTD unit number (i.e. instrument number) (e.g. 6)
sss = station number (e.g. 046)
xxx = file type (e.g. "raw" for raw data file)
n = dip number (i.e. 1 for downcast data, 2 for upcast burst data) (does not apply to 2 dbar-averaged files)

The various file suffixes (xxx in the above naming convention) are

raw = raw data file
cda = intermediate data file, which is the raw data file despiked and with pressure reversal removed, and with appropriate data lagging applied between parameters
unc = uncalibrated 2 dbar-averaged file
ave = calibrated (except for dissolved oxygen) 2 dbar-averaged file
oxy = same as ave, but including the oxygen current derivative with respect to time (for the calibration of dissolved oxygen)
all = final calibrated 2 dbar-averaged file (with or without dissolved oxygens)

A2.2.2 Hydrology data files

The final hydrology data file produced on shore contains the Niskin bottle data, output from the hydrology data processing program "HYDRO" (Appendix 3), merged with averages calculated from upcast CTD burst data. The file is named vyycc.bot (e.g. a9407.bot), where v, yy and cc are as above in the CTD file naming convention. During the CTD calibration procedure, intermediate hydrology data files are produced, named calib.dat:nn (e.g. 01), where "nn" is the version number. In general, the later version numbers are for more advanced stages in the quality control of Niskin bottle data.

A2.2.3 Station information file

This file contains station information, including position, time, depth etc. The file is named vyycc.sta (e.g. a9407.sta), where v, yy and cc are as above.

A2.3 STATION HEADER INFORMATION

Position: All station position information is derived from the quality controlled GPS underway measurement data set (section 4.2, and Appendix 4).

Bottom depth: On the Aurora Australis, bow thrusters are used to maintain station. Unfortunately, the turbulence caused by the thrusters interferes with the echo sounder readings, so that the digital output from the sounder is unusable while thrusters are engaged on station. Depths while on station (Table 2) are obtained by reading the echo sounder printout, and are entered manually to the CTD data logging PC at sea. The automatically logged underway depth measurements immediately before and after station (i.e. when the bow thrusters are not in operation) are later used to check the plausibility of the manually entered values.

Times: All start and end times recorded in the header information are stamped automatically by the CTD data acquisition program at the start and end of CTD data logging. Times are derived from the internal clock on the logging PC; this clock is independent of the ship's main time log, but is checked prior to each station. Bottom times (i.e. time at the bottom of the CTD cast) are as recorded manually at the bottom of each cast during data logging.

A2.4 CONVERTING SHIP-LOGGED RAW DATA FILES FOR SHORE-DATA PROCESSING

For the CTD instruments used on the Aurora Australis, the raw binary data files (as logged by the PC system on board the ship) are binary files consisting of data scans with length n bytes, where the value of n is fixed for each CTD instrument (Table 8). All further CTD data processing on shore is carried out on a Unix system.

For each station, the raw binary data is split into two binary files:

vyyccuss.raw:1 (also known as the "dip 1" file) e.g. a94076046.raw:1
vyyccuss.raw:2 (also known as the "dip 2" file) e.g. a94076046.raw:2

The dip 1 file contains the CTD data (uncalibrated), where only the downcast data has been preserved (down to the maximum pressure value recorded by the pressure sensor prior to the first Niskin bottle firing.) The dip 2 file contains CTD data bursts extracted from the upcast portion of the data at times corresponding to Niskin bottle firings. At each bottle firing, the 5 seconds of CTD data previous to the firing is stored in the dip 2 file.

A2.5 PRODUCING THE DATA PROCESSING MASTER FILE

A master file named "ctdmaster.sho" is created as a template from CTD header information. This file stores all data processing and calibration information, including station header details (e.g. positions, times, maximum pressure etc.), calibration coefficients, calibration status, and digitiser channel information. The master file is automatically updated by the data processing and calibration programs at all stages of the calibration procedure.

A2.6 CALCULATION OF PARAMETERS

The CTD pressure (including pressure temperature) and temperature sensor calibration coefficients (Appendix 1) are written to the master file - pressure and temperature data used at all further stages of the data processing are calibrated values. The conductivity and dissolved oxygen sensors are calibrated entirely from cruise Niskin bottle data, thus final conductivity and dissolved oxygen calibration coefficients are not included till a later stage in the processing. Note that for pressure, temperature, conductivity, salinity and parameters for additional digitiser channels, calculations (including application of calibration coefficients) are performed on the raw data prior to averaging into 2 dbar intervals. The calibration of dissolved oxygen data is performed on the 2 dbar averaged data only.

A2.6.1 Surface pressure offset

The point at which the CTD enters the water is found by identifying the first conductivity value greater than 10 mS/cm. The second data scan after this is then nominated as the first "in water" value. The value of the pressure for this scan is usually slightly greater than or less than zero, due both to atmospheric pressure variation, and to small calibration drift in the pressure sensor. The surface pressure offset value p_{off} , equal to -1 times the pressure reading when the CTD enters the water, is retained for each station (Table 11), and each offset is added to all pressure values for the station. Note that calibrated pressures, including the pressure temperature correction (section A2.6.2), are used when finding p_{off} values.

A2.6.2 Pressure calculation

As discussed in the main text, hysteresis displayed by the new titanium strain gauge pressure sensors is greatly reduced compared to the older stainless steel type pressure sensors. Calibration points from the increasing pressure calibration run only were used to produce a single third order fit for pressure (Appendix 1), applicable to both increasing and decreasing pressure (note that the difference between increasing and decreasing pressure calibrations due to hysteresis was, at greatest, 1 dbar). A further correction is made for the temperature at the pressure sensor (Millard et al., 1993), as measured by the pressure temperature sensor. Final calibrated pressure p is given by

$$p = (p_{\text{cal0}} + p_{\text{off}}) + p_{\text{cal1}} \cdot p_{\text{raw}} + p_{\text{cal2}} \cdot p_{\text{raw}}^2 + p_{\text{cal3}} \cdot p_{\text{raw}}^3 + p_{\text{corr}} \quad (\text{eqn A2.1})$$

where p_{cal0} to p_{cal3} are the pressure sensor calibration coefficients, and p_{raw} is the raw pressure output by the CTD in digitiser counts. p_{corr} is the pressure temperature correction term, given by

$$p_{\text{corr}} = (S_2 + S_1 \cdot p_{\text{raw}}) \cdot (T_p - T_0) \quad (\text{eqn A2.2})$$

(Millard et al., 1993). S_1 and S_2 (supplied by the manufacturer) are pressure temperature correction slope and bias terms respectively, while T_0 is the room temperature at which the pressure sensor calibration was obtained (i.e. where p_{cal0} to p_{cal3} were obtained) (Appendix 1). The calibrated pressure temperature T_p is given by

$$T_p = T_{\text{pcal0}} + T_{\text{pcal1}} \cdot T_{\text{praw}} + T_{\text{pcal2}} \cdot T_{\text{praw}}^2 + T_{\text{pcal3}} \cdot T_{\text{praw}}^3 \quad (\text{eqn A2.3})$$

where T_{pcal0} to T_{pcal3} are the pressure temperature sensor calibration coefficients (Appendix 1), and T_{praw} is the raw pressure temperature output by the CTD in digitiser counts.

The CTD pressure was calibrated over the range 0 to 6203 dbar (Appendix 1). No greater pressures were reached during the cruise.

A2.6.3 Temperature calculation

CTD temperature values are in terms of the International Temperature Scale of 1990 (ITS-90). A quadratic fit is used for calibration of the temperature data, as follows:

$$T = T_{cal0} + T_{cal1} \cdot T_{raw} + T_{cal2} \cdot T_{raw}^2 \quad (\text{eqn A2.4})$$

where T is the calibrated temperature, T_{cal0} , T_{cal1} and T_{cal2} are temperature calibration coefficients (Appendix 1), and T_{raw} is the raw temperature output by the CTD in digitiser counts. When conversion of temperature as ITS-90 to temperature expressed on the International Practical Temperature Scale of 1968 (IPTS-68) is required (e.g. for salinity PSS-78 calculation), the following conversion factors are used (Saunders, 1990):

$$T_{68} = 1.00024 T_{90} \quad (\text{eqn A2.5})$$

$$T_{90} = 0.99976 T_{68} \quad (\text{eqn A2.6})$$

A2.6.4 Conductivity cell deformation correction

Conductivity cell geometry is effected by temperature and pressure. The correction applied for this cell deformation is

$$c = g_{ctd} \cdot [1 - 6.5e^{-6} (T - 2.8) + 1.5e^{-8} (p - 3000)] \quad (\text{eqn A2.7})$$

for conductivity c , calibrated temperature and pressure T and p respectively, and where g_{ctd} is the raw conductance g_{raw} as measured by the CTD and converted to approximate engineering units by

$$g_{ctd} = g_{raw} / 1000 \quad (\text{eqn A2.8})$$

A2.6.5 Salinity calculation

Salinity is calculated from the conductivity, temperature and pressure using the practical salinity scale of 1978 (PSS-78), via the algorithm SAL78 (Fofonoff and Millard, 1983). Note that temperatures expressed on the ITS-90 scale must first be converted to IPTS-68 temperatures (eqn A2.5) for input into the salinity PSS-78 routine.

A2.6.6 Oxygen current and oxygen temperature conversion

The raw oxygen current and oxygen temperature, o_{craw} and o_{traw} respectively as measured by the CTD, are converted to o_{cctd} and o_{tctd} in approximate engineering units by

$$o_{cctd} = o_{craw} / 80000 \quad (\text{eqn A2.9})$$

$$o_{tctd} = o_{traw} / 6000 \quad (\text{eqn A2.10})$$

Calibration of the dissolved oxygen using these parameters is performed on 2 dbar averages only.

A2.6.7 Additional digitiser channel parameters

Manufacturer supplied polynomial fit coefficients are applied to digitiser channel parameters (Appendix 1). No further calibration is applied to these values.

A2.7 CREATION OF INTERMEDIATE CTD FILES, AND AUTOMATIC QUALITY FLAGGING OF CTD BURST DATA

Several processing steps take place when the intermediate CTD files are produced (section A2.7.5). Briefly, the parameters are despiked, sensor lagging corrections are applied, and pressure reversals are removed. For the upcast CTD burst data, individual bursts are automatically assigned a quality code.

A2.7.1 Despiking

Spurious data points are replaced by the previous data point. This preserves the equal time spacing between data points, required for the sensor lagging corrections discussed below. The criteria used to reject data values are shown in Table A2.1. Note that these criteria are unchanged over the entire water column.

For pressure, temperature, conductivity and salinity, if any one of these parameters falls outside the criteria for acceptable data (Table A2.1), then the entire data scan is replaced by the previous data scan (i.e. all parameters are replaced by the previous value), and the scan replacement counter nrep is incremented by 1. If more than 3 consecutive data scans require replacement by the previous scan (i.e. nrep > 3), then all parameters are reset to their current value (i.e. the scan is not replaced by the previous scan) and nrep is reset to 0.

Table A2.1: Criteria used to determine spurious data values. The low and high limits are respectively the minimum and maximum allowable values for the parameter. The maximum allowable step is the maximum difference permitted between consecutive values.

parameter	units	low limit	high limit	maximum allowable step
pressure	dbar	0	6203	1.0
temperature	°C	-5	32	1.0
conductivity	mS.cm ⁻¹	5	80	1.0
salinity	psu	10	50	0.25
oxygen current	µA	0	2	0.25
oxygen temperature	°C	-5	32	1.0

For oxygen current o_c and oxygen temperature o_t , if either of these parameters falls outside the criteria in Table A2.1, then the current o_c and o_t values are replaced by null data points; the other parameters are unaffected, and nrep is not incremented. Note that when o_c and o_t are replaced by null values, then the maximum allowable step criterion (Table A2.1) is not applied to the next o_c and o_t values; however the low and high limit tests (Table A2.1) are still applied.

For any parameters from the additional digitiser channels, no automatic check is made for spurious data values.

A2.7.2 Sensor lagging corrections

Lag corrections are required to compensate for the different response times of the sensors. Data from the faster sensors (pressure and conductivity) are slowed down to match the slowest sensor (temperature). A recursive filter (Millard, 1982) is used to lag the pressure and conductivity data, of the form

$$y(t) = y(t - dt) \cdot W_0 + x(t) \cdot W_1 \quad (\text{eqn A2.11})$$

where

$y(t)$ = output lagged conductivity or pressure at time t

dt = recording interval of the instrument

$x(t)$ = input conductivity or pressure prior to lagging

$W_0 = \exp(-dt / \tau)$

$W_1 = 1 - W_0$

The time constant τ is obtained as follows. The response of the pressure sensor is assumed to be instantaneous; the response time of the conductivity cell is taken as 0.03 seconds, which is equal to the flushing time of the 3 cm conductivity cell at a lowering rate of 1 m.s^{-1} . Thus for τ_T equal to the response time of the temperature sensor, we have

$$\tau = \tau_T \quad \text{when pressure is being lagged, and}$$

$$\tau = \tau_T - 0.03 \quad \text{when conductivity is being lagged.}$$

τ_T is obtained by performing a cross-correlation between the temperature and conductivity data to determine the response difference between the two sensors. Typically, a value of 0.205 s is used for τ_T (Table 8).

The same recursive filter (eqn A2.11) is applied to the oxygen current and oxygen temperature, as well as to data in the additional digitiser channels. For all these parameters, the value $\tau = \tau_T$ is used for the time constant.

A2.7.3 Pressure reversals

After despiking and application of the lagging correction, for downcast data all pressure reversals are removed. Stepping through the data scans, the maximum pressure value is updated each time the pressure increases, and the scan is written to the intermediate CTD file (including the case where pressure does not change); data scans with a pressure value less than the current maximum pressure value are not written to the intermediate file. Thus for downcast data, the intermediate CTD file contains data for non-decreasing pressure. For upcast burst data, pressure reversals are not removed.

A2.7.4 Upcast CTD burst data

A burst of CTD data is associated with each firing of a Niskin bottle, each burst consisting of the 5 seconds of CTD data prior to the bottle firing. For each burst, the mean and standard deviation of the parameters are calculated: for these calculations, the first n start and last n end data scans (Table 8) in each burst are ignored. The range of the parameters in each burst is also found (equal to the difference of the maximum and minimum values). The mean values from the burst data are used for comparison with the salinity and dissolved oxygen bottle samples, for the subsequent calibration of the conductivity and dissolved oxygen sensors.

Table A2.2: Criteria for automatic flagging of upcast CTD burst data. The subscripts std and range refer respectively to the standard deviation and range of the parameter over the data burst. The data quality code ical has the following values:

ical=1 acceptable value, used for conductivity calibration
ical=0 questionable value, but still used for conductivity calibration
ical=-1 bad value, not used for conductivity calibration

Note that setting ical to -1 takes precedence over setting ical=0, which in turn takes precedence over setting ical=1.

STANDARD DEVIATION CRITERIA		RANGE CRITERIA	
set ical = -1 for following cases	set ical = 0 for following cases	set ical = -1 for following cases	set ical = 0 for following cases
$4.00 < p_{std}$	$2.00 < p_{std} _ 4.00$		$(T_{range})/(c_{range}) < 0.5$
$0.04 < T_{std}$	$0.02 < T_{std} _ 0.04$		$(T_{range})/(c_{range}) > 2.0$
$0.04 < c_{std}$	$0.02 < c_{std} _ 0.04$		$c_{range} = 0$
$0.01 < s_{std}$	$0.005 < s_{std} _ 0.01$	$0.02 < s_{range}$	$0.01 < s_{range} _ 0.02$
$0.40 < o_{cstd}$	$0.20 < o_{cstd} _ 0.40$		
$0.40 < o_{lstd}$	$0.20 < o_{lstd} _ 0.40$		
$1998 < ad_{std}$	$999 < ad_{std} _ 1998$		

The standard deviations and ranges of the burst data are used to assign a quality code to each burst (Table A2.2). Note that there is only one quality code assigned to each data burst and associated Niskin bottle sample in the hydrology data file: this code refers to values used in the calibration of the CTD conductivity. For the criteria in Table A2.2, setting of the quality code to -1 takes precedence over setting to 0. If none of the criteria are met, the quality code is set to 1 i.e. value accepted for calibration of the conductivity.

The standard deviation x_{std} of parameters x in each data burst is calculated from

$$x_{std} = \left\{ \left[\sum_{i=nstart}^{n-nend} (x_i - \bar{x})^2 \right] / [n - (nstart+nend+1)] \right\}^{1/2} \quad (\text{eqn A2.12})$$

where n is the total number of data points x_i in the burst, and the mean value \bar{x} for each burst is given by

$$\bar{x} = \left(\sum_{i=nstart}^{n-nend} x_i \right) / (n-nstart-nend) \quad (\text{eqn A2.13})$$

A2.7.5 Processing flow

Stepping through the raw data scans one scan at a time, the parameters in the scan first have the calculations and corrections applied, as described in section A2.6. The data is then despiked (section A2.7.1); spurious values are replaced by the previous data scan, up to a maximum of 3 consecutive scans, after which time the scan is reset to the current value. The sensor lagging correction is then applied via the recursive filter (section A2.7.2). When the filter is started, the first $jfilt$ scans (Table 8) are ignored. Note that whenever $nrep > 3$ (section A2.7.1), the filter is restarted, and the first $jfilt$ scans are again ignored. Salinity is recalculated for each data scan, after all lagging corrections have been applied. Data is then written to the intermediate CTD file, removing pressure reversals for the case of downcast data (section A2.7.3). For upcast burst data, statistical calculations are performed and a quality code assigned for each burst (section A2.7.4). The mean values and quality codes for the bursts are written to a template intermediate hydrology data file.

A2.8 CREATION OF 2 DBAR-AVERAGED FILES

Data scans from the intermediate CTD files are sorted into 2 dbar pressure bins, with each bin centered on the even integral pressure value, starting at 2 dbar, as follows. A data scan is placed into the i th 2 dbar pressure bin if

$$p_{mid,i} - 1 < p \leq p_{mid,i} + 1 \quad (\text{eqn A2.14})$$

where $p_{mid,i}$ is the i th 2 dbar pressure bin centre, and p is the pressure value for the data scan.

After sorting, the temperature, conductivity, oxygen current, oxygen temperature and additional digitiser channel values in each 2 dbar bin are averaged and written to the 2 dbar-averaged file. There is no pressure centering of these parameters i.e. for the i th 2 dbar pressure bin, the parameters are assigned to the even integral pressure value at the centre of the bin. Note that if the number of points in a bin is less than j_{min} (Table 8), no averages are calculated for that bin.

The salinity s_{av} for each 2 dbar bin is calculated from T_{av} , c_{av} and p_{mid} , where T_{av} and c_{av} are respectively the temperature and conductivity averages for the bin. Note that T_{av} is first converted from the ITS-90 scale to the IPTS-68 scale using eqn A2.5 (this also applies to the calculations below for σ_T , δ and $\Delta\Phi$).

The following quantities are also calculated for each 2 dbar bin, and are written to the 2 dbar-averaged file:

σ_T : sigma-T is equal to $(\rho - 1000)$, where the density ρ is calculated at the surface, and at the in situ temperature and salinity T_{av} and s_{av} respectively, using the 1980 equation of state for seawater (Millero et al., 1980; Millero and Poisson, 1981).

δ : specific volume anomaly (units $\times 10^8 \text{ m}^3 \cdot \text{kg}^{-1}$), calculated with T_{av} , s_{av} and p_{mid} , using the 1980 equation of state for seawater (Millero et al., 1980; Millero and Poisson, 1981).

$\Delta\Phi$: geopotential anomaly (units $\text{J} \cdot \text{kg}^{-1}$), calculated relative to the sea surface ($p=0$), from

$$\Delta\Phi = \int_{p=0}^{p=p_{mid}} \delta \cdot dp \quad (\text{eqn A2.15})$$

n_{bin} : number of points in the 2 dbar bin

T_{bin_std} : standard deviation of all temperature values in the bin

c_{bin_std} : standard deviation of all conductivity values in the bin

When 2 dbar averages are calculated for oxygen current and oxygen temperature, an additional test is made to exclude suspect oxygen data, as follows. For a 2 dbar bin, if we have either

standard deviation of binned $o_c > 0.1$

or

standard deviation of binned $o_t > 0.5$

then the following 2 conditions must be met for a scan to be included in the averaging of o_c and o_t for the bin:

$$0 < o_c \leq 2.047 \quad (\text{eqn A2.16})$$

$$|o_t - T| \leq 5 \quad (\text{eqn A2.17})$$

After this test has been made, if the number of scans in the bin has been reduced by more than half, then no o_c or o_i data is included for the bin.

A2.9 HYDROLOGY DATA FILE PROCESSING

An intermediate hydrology data file is formed by merging the results from the salinity, dissolved oxygen and nutrient laboratory analyses with the averages calculated from the upcast CTD burst data (section A2.7.4). Prior to calibration of the CTD conductivity and dissolved oxygen data, the Niskin bottle data undergo preliminary quality control. Salinity bottle data which are obviously bad are given the quality code -1 (i.e. bottle not used for calibration of CTD conductivity) in the intermediate hydrology data file. Reasons for rejecting salinity bottle data at this stage include bad samples due to leaking or incorrectly tripped Niskin bottles, mixed up samples due to misfiring rosette pylon, samples drawn out of sequence from Niskin bottles, etc.

Dissolved oxygen bottle data pass through an initial quality control similar to salinity bottle data, except that bad dissolved oxygen bottle values are deleted from the hydrology data file. Questionable dissolved oxygen bottle values (not deleted) are noted (Table 21). Suspect reversing thermometer readings are also deleted at this stage. Nutrient data are quality controlled at a later stage, following calibration of all the CTD data.

A2.10 CALIBRATION OF CTD CONDUCTIVITY

For the CTD conductivity data, calibrations are carried out by comparing the upcast CTD burst data with the hydrology data, then applying the resulting calibrations to the downcast CTD data. The conductivity calibration follows the method of Millard and Yang (1993). For groups of consecutive stations, a conductivity slope and bias term are found to fit the CTD conductivity from the upcast burst data to the hydrology data; a linear station-dependent slope correction (Millard and Yang, 1993) is applied to account for calibration drift of the CTD conductivity cell. Note that data from the entire water column are used in the conductivity calibration. Also note that no correction is made for the vertical separation of the Niskin bottles and the CTD sensors (of the order 1 m).

A2.10.1 Determination of CTD conductivity calibration coefficients

The following definitions apply for the conductivity calibration:

- c_{ctd} = uncalibrated CTD conductivity from the upcast burst data
- c_{cal} = calibrated CTD conductivity from the upcast burst data
- c_{btl} = 'in situ' Niskin bottle conductivity, found by using CTD pressure and temperature from the burst data in the conversion of Niskin bottle salinity to conductivity
- F_1 = conductivity bias term
- F_2 = conductivity slope term
- F_3 = station-dependent conductivity slope correction
- N = station number

CTD conductivities are calibrated by the equation

$$c_{cal} = (1000 c_{ctd}) \cdot (F_2 + F_3 \cdot N) + F_1 \quad (\text{eqn A2.18})$$

Niskin bottle salinity data are first converted to 'in situ' conductivities c_{btl} . The ratio c_{btl}/c_{cal} for all bottle samples is then plotted against station number, along with the mean and standard deviation of the ratio for each station (Figure 3 is the version of this plot for the final calibrated data). Groups of consecutive stations are selected to follow approximately linear trends in the drift of the station-mean c_{btl}/c_{cal} (Table 13). For each of these groups, the three calibration coefficients F_1 , F_2 and F_3 are found by a least squares fit: F_1 , F_2 and F_3 in eqn A2.18 are all varied to minimize the variance σ^2 of the conductivity residual ($c_{btl} - c_{cal}$), where σ^2 is defined by

$$\sigma^2 = \frac{(c_{\text{btl}} - c_{\text{cal}})^2}{(n - 1)} \quad (\text{eqn A2.19})$$

for n equal to the total number of bottle samples in the station grouping.

Note that samples with a previously assigned quality code of -1 (sections A2.7.4. and A2.9) are excluded from the above calculations. In addition, samples for which

$$| (c_{\text{btl}} - c_{\text{cal}}) | > 2.8 \sigma \quad (\text{eqn A2.20})$$

are also flagged with the quality code -1, and excluded from the final calculation of the conductivity calibration coefficients F_1 , F_2 and F_3 . Samples rejected at this stage often include those collected in steep vertical temperature and salinity gradients, and not already rejected.

A2.10.2 Application of CTD conductivity calibration coefficients

The set of coefficients F_1 , F_2 and F_3 found for each station (Tables 13 and 14) are first used to calibrate the upcast CTD conductivity burst data in the hydrology data file. The conductivity calibration is applied to the mean value for each burst only (as opposed to each raw data scan in the burst). Similarly, upcast CTD salinity burst values are recalculated from the calibrated CTD burst mean values of conductivity, temperature and pressure.

Next, the intermediate CTD files are reproduced (as per section A2.7) for the downcast data only. Note that on this occasion, following application of the conductivity cell deformation correction (eqn A2.7), the coefficients F_1 , F_2 and F_3 are used to calibrate the raw conductivity data scans. The 2 dbar-averaged CTD downcast data are then recalculated, as in section A2.8.

A2.10.3 Processing flow

The intermediate hydrology file data, containing upcast CTD burst data means and Niskin bottle data, are used to determine the conductivity calibration coefficients F_1 , F_2 and F_3 . Station groupings are determined from the bias drift of the conductivity cell with time (section A2.10.1). For each station group, the following occurs:

1. 3 iterations are made of the least squares fitting procedure (section A2.10.1) to calculate F_1 , F_2 and F_3 , each iteration beginning with the latest value for the coefficients;
2. bottles are rejected according to the criterion of eqn A2.20;
3. steps 1 and 2 are repeated until no further bottle rejection occurs.

For each station group, there is a single value for each of the 3 coefficients F_1 , F_2 and F_3 (Table 13); following the station-dependent correction, an individual corrected slope term ($F_2 + F_3 \cdot N$) (as in eqn A2.18) applies to each station (Table 14). When final values of the coefficients have been obtained, the conductivity calibration is applied to both the upcast CTD burst data and the downcast CTD data (section A2.10.2). Finally, plots are made of both the ratio $c_{\text{btl}}/c_{\text{cal}}$ and the residual ($s_{\text{btl}} - s_{\text{cal}}$) versus station number (Figures 3 and 4), where s_{btl} is the Niskin bottle salinity and s_{cal} is the calibrated CTD salinity from the upcast burst data (section A2.10.2).

Following calibration of the CTD conductivity, the mean of the salinity residuals ($s_{\text{btl}} - s_{\text{cal}}$) for the entire data set is equal to 0. The standard deviation about 0 of the salinity residual (section A2.14) provides an indicator for the quality of the data set. To meet WOCE specifications, this standard deviation should be less than or equal to 0.002 psu (Joyce et al., 1991).

A2.11 QUALITY CONTROL OF 2 DBAR-AVERAGED DATA

Two levels of quality control are undertaken for the 2 dbar-averaged data. Suspicious raw data scans, indicated by suspicious 2 dbar averages, are flagged for later action (Table 15); and remaining suspect 2 dbar averages are noted (Tables 16 and 17) (suspect 2 dbar averages are rarely removed directly).

A2.11.1 Investigation of density inversions

The calibrated 2 dbar-averaged data are searched automatically for density inversions i.e. for instances where the in situ density (calculated from in situ pressure, temperature and salinity) decreases with depth. Raw CTD data in the vicinity of the density inversions are then examined for anything which might artificially cause the inversions. The most commonly encountered problems are

- (a) water from the wake of the moving instrument package catching up to the CTD sensors during rolls induced by surface waves;
- (b) fouling of the CTD sensors;
- (c) salinity spikes caused by mismatching of the temperature and conductivity data in very steep vertical gradients, where the sensor lagging corrections (section A2.7.2) are not adequate;
- (d) bad pressure temperature data caused by a malfunctioning dissolved oxygen sensor, as described in section 6.1.2 of the main text (note that in this case, density inversions do not always result).

If these or any other problems are identified in the raw CTD data, one of two possible actions follow:

- (i) the relevant data scans are ignored for all further calculations - a counter preserves the constant scanning frequency required for application of the sensor lagging corrections; note that for cases where the ignoring of raw data scans results in missing 2 dbar averages, a linear interpolation is applied between surrounding 2 dbar averages to fill any data gaps (Table 18);
- (ii) a linear interpolation is applied over the region of bad data, in which case the interpolation is applied to the raw CTD data scans prior to any calibration calculations.

The status of data scans flagged for special treatment (Table 15) is updated in the data processing master file (section A2.5).

For the case of bad pressure temperature data, pressure temperature profiles from other stations (see section 6.1.2 in the main text for an example) may be used to allow calculation of the pressure from eqns A2.1 to A2.3.

A2.11.2 Manual inspection of data

Data plots of the 2 dbar-averaged data are inspected to identify any additional suspicious data. Suspect values remaining are most commonly due to the following:

- (a) large salinity spikes (as in section A2.11.1) in very steep gradients in the thermocline - for these large salinity spikes, 2 dbar averages are flagged instead of raw data scans (Table 16);
- (b) suspect data near the surface due to transient effects of the sensors entering the water (e.g. bubbles trapped on sensors, or fouling) (Table 17).

2 dbar-averaged data regarded as suspicious for these or any other reasons are flagged accordingly.

A2.12 CALIBRATION OF CTD DISSOLVED OXYGEN

For the CTD dissolved oxygen data, the calibration procedure is carried out using the downcast uncalibrated CTD data. Downcast CTD data is matched with the Niskin bottle dissolved oxygen samples on equivalent pressures. The calibration is based on the method of Owens and Millard (1985).

A2.12.1 Determination of CTD dissolved oxygen calibration coefficients

The following definitions apply for the dissolved oxygen calibration:

o_{cal} = calibrated CTD dissolved oxygen
 o_c = CTD oxygen current
 o_t = CTD oxygen temperature
 T = CTD temperature
 s = CTD salinity
 p = CTD pressure
 $\partial o_c / \partial t$ = oxygen current derivative with respect to time
 K_1 = oxygen current slope
 K_2 = oxygen sensor time constant
 K_3 = oxygen current bias
 K_4 = temperature correction term
 K_5 = weighting factor of o_t relative to T
 K_6 = pressure correction term
 o_{btl} = Niskin bottle dissolved oxygen value

All the above CTD parameters are 2 dbar-averaged data. CTD dissolved oxygen is calibrated using the sensor model of Owens and Millard (1985), as follows:

$$o_{cal} = [K_1 \cdot (o_c + K_2 \cdot \partial o_c / \partial t + K_3)] \cdot \text{oxsat}(T,s) \cdot \exp\{ K_4 \cdot [T + K_5 \cdot (o_t - T)] + K_6 \cdot p \} \quad (\text{eqn A2.21})$$

where the oxygen saturation value oxsat is calculated at T and s using the formula of Weiss (1970):

$$\text{oxsat}(T,s) = \exp\{ A_1 + A_2 \cdot (100/T_K) + A_3 \cdot \ln(T_K/100) + A_4 \cdot (T_K/100) + s \cdot [B_1 + B_2 \cdot (T_K/100) + B_3 \cdot (T_K/100)^2] \} \quad (\text{eqn A2.22})$$

for T_K equal to the CTD temperature in degrees Kelvin ($=T+273.16$), and the additional coefficients having the values (Weiss, 1970):

$$\begin{array}{ll} A_1 = -173.4292 & B_1 = -0.033096 \\ A_2 = 249.6339 & B_2 = 0.014259 \\ A_3 = 143.3483 & B_3 = -0.0017 \\ A_4 = -21.8492 & \end{array}$$

Note that the CTD temperature T in equations A2.21 and A2.22 is first converted from the ITS-90 scale to the IPTS-68 scale using eqn A2.5.

$\partial o_c / \partial t$ in eqn A2.21 is calculated as follows. A time base is first estimated from the 2 dbar averaged data by assigning the time t_k in seconds at the k th 2dbar value equal to

$$t_k = \left[\sum_{i=1}^{k-1} \text{nbins}_i / 25 \right] + (\text{nbins}_k / 50) \quad (\text{eqn A2.23})$$

where nbins_k is the number of data scans in the k th 2 dbar bin (for bins with no data points, nbins is set to 25). Note that this time base is an approximation only, as nbins does not include data scans in

pressure reversals (sections A2.7.3 and A2.8), and in addition, a constant lowering rate of the instrument package is being assumed. $\partial o_e / \partial t$ is then calculated at the kth 2 dbar value by applying a linear regression over a 16 dbar interval centered on the kth 2 dbar value: $\partial o_e / \partial t$ is the slope of the linear best fit line of the oxygen currents

$$(o_{ck-4}, o_{ck-3}, o_{ck-2}, o_{ck-1}, o_{ck}, o_{ck+1}, o_{ck+2}, o_{ck+3}, o_{ck+4})$$

to the times

$$(t_{k-4}, t_{k-3}, t_{k-2}, t_{k-1}, t_k, t_{k+1}, t_{k+2}, t_{k+3}, t_{k+4}).$$

If there is no data for either of o_{ck} or o_{tk} (section A2.8), a null value is assigned to $(\partial o_e / \partial t)_k$.

In most cases, CTD dissolved oxygen is calibrated for individual stations; station groupings (as in the CTD conductivity calibration) may be formed to cover casts with few Niskin samples, or else for deep/shallow cast pairs at a single location. For each individual station, or each station grouping, the calibration coefficients K_1 to K_6 in eqn A2.21 are found by varying some or all of the 6 coefficients in order to minimize the variance σ^2 of the dissolved oxygen residual $o_{btl} - o_{cal}$ where σ^2 is defined by

$$\sigma^2 = \frac{\sum (o_{btl} - o_{cal})^2}{(n-1)} \quad (\text{eqn A2.24})$$

for n equal to the total number of bottle samples at the station (or in the station grouping). A non-linear least squares fitting routine, utilising the subroutines MRQMIN, MRQCOF, COVSRT and GAUSSJ in Press et al. (1986), is applied to find K_1 to K_6 . In application of the routine, convergence is judged to have occurred when

$$\frac{\sum (o_{btl} - o_{cal})^2}{(0.6)^2} < 0.96 n \quad (\text{eqn A2.25})$$

or else after a maximum of 5 iterations. Note that when calculating σ^2 for each Niskin bottle sample, the pressure from the upcast CTD burst data (i.e. the pressure assigned to the bottle sample) is used in eqn A2.21, while all other parameters are from the downcast data (at the nearest equivalent 2 dbar pressure value). Downcast CTD pressure is used in eqn A2.21 when the resulting calibration is being applied to finalise the entire 2 dbar dissolved oxygen data. Also note that there is no automatic rejection of dissolved oxygen bottle data analogous to eqn A2.20 in the conductivity calibration.

A2.12.2 Application of CTD dissolved oxygen calibration coefficients

The set of coefficients K_1 to K_6 found for each station or station grouping (Table 19) are used in eqn A2.21 to calculate CTD dissolved oxygen 2 dbar data from the existing 2 dbar pressure, temperature, salinity, oxygen current and oxygen temperature data.

A2.12.3 Processing flow

* The *.oxy* files (section A2.2.1), which include values of $\partial o_e / \partial t$ (calculated as in section A2.12.1) as well as all the other downcast 2 dbar data, are first created from the existing calibrated 2 dbar-averaged files.

* For each station, the upcast CTD burst pressure values from the hydrology data file (sections A2.7.4 and A2.7.5) are matched to the closest 2 dbar pressure values in the *.oxy* file; then for each Niskin bottle sample, the following data are written to the file *oxydwn.dat*.

p (upcast CTD burst value)
 T, s, o_c , o_t , $\partial o_e / \partial t$ (all 2 dbar downcast values)
 o_{btl}
 o_{btl} quality code

The -1 bottle quality code (sections A2.7.4 and A2.9) is not relevant to the dissolved oxygen calibration. Instead, a code of -9 in the *oxydwn.dat* file indicates that the bottle is not used for the dissolved oxygen calibration calculations.

* All calibration calculations are performed on dissolved oxygen (i.e. Niskin bottle and CTD dissolved oxygen values, and oxygen saturation values) in units of ml/l; all values are reported in units of $\mu\text{mol/l}$. The conversion factor used is

$$(\mu\text{mol/l}) = 44.6596 \cdot (\text{ml/l}) \quad (\text{eqn A2.26})$$

* The fitting routine is applied to find values of the coefficients K_1 to K_6 (section A2.12.1), using the data in the *oxydwn.dat* file. The number of coefficients varied may be chosen, as well as the starting values for the coefficients prior to iteration (Table 20). Starting values are typically close to the following:

$$\begin{array}{ll} K_1 = 2.50 & K_4 = -0.036 \\ K_2 = 8.0 & K_5 = 0.75 \\ K_3 = 0.0 & K_6 = 0.00015 \end{array}$$

With successive attempts at fitting the CTD data to the Niskin bottle data, bottles which are suspect are flagged manually with the quality code -9 in *oxydwn.dat*, and are rejected for further calibration attempts (Appendix 5, Table A5.2). The number of coefficients chosen to vary, and the coefficient starting values, are varied to achieve the best fit of the CTD to the bottle data. In general, the fit for a station (or group of stations) is not considered satisfactory until $2.8\sigma < 0.3$ (for σ defined as in eqn A2.24) (Table 19).

* Following calibration of the CTD dissolved oxygen, the residuals ($o_{\text{btl}} - o_{\text{cal}}$) are plotted against station number (Figure 5). The mean of the residuals for the entire data set is very close to 0. The standard deviation about the mean of the residuals (section A2.14) provides an indicator for the quality of the data set. To meet WOCE specifications (Joyce et al., 1991), this standard deviation should be less than 1% of the maximum data value i.e. approximately $< 2.5 \mu\text{mol/l}$ below 750 dbar, and approximately $< 3.5 \mu\text{mol/l}$ above 750 dbar, for the data set presented in this report.

A2.13 QUALITY CONTROL OF NUTRIENT DATA

Nutrient data which are obviously bad are removed from the hydrology data file. Causes of bad samples include leaking or incorrectly tripped Niskin bottles, and errors occurring during sampling or analysis. On occasion, autoanalyser errors may necessitate the flagging of an entire station as suspect. The data are checked by overlaying vertical profiles of groups of consecutive stations, looking at bulk plots (e.g. nitrate versus phosphate) of large numbers of stations, and by comparing values to any available historical data. Questionable nutrient data (not obviously bad, and therefore not deleted from the hydrology data file) are noted (Table 22).

A2.14 FINAL CTD DATA RESIDUALS/RATIOS

The final residuals ($T_{\text{therm}} - T_{\text{cal}}$), ($S_{\text{btl}} - S_{\text{cal}}$) and ($o_{\text{btl}} - o_{\text{cal}}$) are plotted (Figures 2, 4 and 5) for temperature, salinity and dissolved oxygen (T_{therm} and T_{cal} are respectively the protected thermometer and calibrated upcast CTD burst temperature values); for conductivity, the ratio $c_{\text{btl}}/c_{\text{cal}}$ is plotted (Figure 3). The plots include mean and standard deviation values, as follows:

temperature, salinity and dissolved oxygen: The standard deviations of the residuals for temperature, salinity and dissolved oxygen are calculated from

$$x_{\text{std}} = \left\{ \left[\sum_{i=1}^n (x_i - x_{\text{mean}})^2 \right] / (n - 1) \right\}^{1/2} \quad (\text{eqn A2.27})$$

where x_{std} is the standard deviation of x (for x equal to the temperature, salinity or dissolved oxygen residual). For both temperature and salinity, the summation in eqn A2.27 does not include points rejected for the CTD conductivity calibration. Similarly for dissolved oxygen, the summation does not include points rejected for the CTD dissolved oxygen calibration. Thus n is equal to the total number of data points x_i not rejected for the relevant calibration, with mean value x_{mean} of the x_i values (x_{mean} is the mean for all the stations in the plot).

conductivity: The standard deviation of the conductivity ratio is calculated as in eqn A2.27, except that in the summation, for each point x_i the value x_{mean} is the mean for the particular station to which x_i belongs. x in eqn A2.27 is equal to the conductivity ratio. The summation in eqn A2.27 does not include points rejected for the CTD conductivity calibration.

A2.15 CONCLUSIONS

A complete description is presented of the CTD data calibration methods. Sufficient details are supplied to minimize the need for cross-referencing, and to provide a useful reference for comparison with the calibration methods used by other institutions. Any variation in the techniques employed at each stage of the processing, and the order in which the various techniques are applied, ultimately affect the final data values produced. As such, all CTD data sets need to be considered in conjunction with the calibration details.

ACKNOWLEDGEMENTS

Many thanks go to Neil White and Dave Vaudrey at CSIRO Division of Oceanography, who created the bulk of the CTD calibration software, and familiarised me with the contents.

REFERENCES

- Fofonoff, N.P. and Millard, R.C., Jr., 1983. *Algorithms for computation of fundamental properties of seawater*. UNESCO Technical Papers in Marine Science, No. 44. 53 pp.
- Joyce, T., Corry, C. and Stalcup, M., 1991. *Requirements for WOCE Hydrographic Programme Data Reporting*. WHP Office Report WHPO 90-1, Revision 1, WOCE Report No. 67/91, Woods Hole Oceanographic Institution. 71 pp.
- Millard, R.C., Jr., 1982. CTD calibration and data processing techniques at WHOI using the 1978 Practical Salinity Scale. *Proceedings of the International STD Conference and Workshop*.
- Millard, R.C. and Yang, K., 1993. *CTD calibration and processing methods used at Woods Hole Oceanographic Institution*. Woods Hole Oceanographic Institution Technical Report No. 93-44. 96 pp.
- Millard, R., Bond, G. and Toole, J., 1993. Implementation of a titanium strain gauge pressure transducer for CTD applications. *Deep-Sea Research I*, Vol. 40, No. 5, pp1009-1021.
- Millero, F.J., Chen, C.-T., Bradshaw, A. and Schleicher, K., 1980. A new high-pressure equation of state for seawater. *Deep-Sea Research*. **27a**: 255-264.
- Millero, F.J. and Poisson, A., 1981. International one-atmosphere equation of state of seawater. *Deep-Sea Research*. **28a**: 625-629.
- Owens, W.B. and Millard, R.C., Jr., 1985. A new algorithm for CTD oxygen calibration. *Journal of Physical Oceanography*. **15**: 621-631.
- Press, W.H., Flannery, B.P., Teukolsky, S.A. and Vetterling, W.T., 1986. *Numerical Recipes. The Art of Scientific Computing*. Cambridge University Press. 818 pp.
- Rosenberg, M., Eriksen, R. and Rintoul, S., 1995. *Aurora Australis marine science cruise AU9309/AU9391 - oceanographic field measurements and analysis*. Antarctic Cooperative Research Centre, Research Report No. 2, March 1995. 103 pp.
- Saunders, P.M., 1990. The International Temperature Scale of 1990. ITS-90. *WOCE Newsletter*, **10**, IOS, Wormley, UK.
- Weiss, R.F., 1970. The solubility of nitrogen, oxygen and argon in water and seawater. *Deep-Sea Research*. **17**: 721-735.

APPENDIX 3 Hydrology Analytical Methods

This Appendix covers the analytical techniques and data processing routines employed in the Hydrographic Laboratory onboard the RSV Aurora Australis for cruise AU9407, January 1 to March 1, 1994. All analysis results are merged with station details in the program "HYDRO" (CSIRO Division of Oceanography). Output from HYDRO is ultimately used for merging with CTD data.

A limited replicate sample set was obtained from several stations. Estimates of nutrient, dissolved oxygen and salinity precision derived from these data are discussed in section 6.2.2 of the main text.

All methods are fully documented in a hydrology manual (Eriksen, in preparation).

A3.1 NUTRIENT ANALYSES

A3.1.1 Equipment and technique

Nutrient analyses were performed by two analysts from the Antarctic CRC. An Alpkem "Flow Solution" Autoanalyser was used for the simultaneous analysis of reactive silicate, nitrate plus nitrite, and orthophosphate in seawater. All analyses were carried out in the Segmented Flow Analysis (SFA) mode, although the instrument can be configured for Flow Injection Analysis. Data output from the autoanalyser was processed by the commercial software package "DAPA" (Data Acquisition Processing Analysis Scientific Version 1.43, Curtin University, Box 58 Kalamunda Western Australia 6070).

The 510 Monochromator Detectors in the Alpkem instrumentation were mounted on foam pads 8 cm thick, to insulate them from the constant vibration caused by the ship's engines, ice breaking etc. Previous voyages had shown that the 510 detectors are very susceptible to air bubbles lodging in the flow cell when the unit is subjected to high frequency vibration (Rosenberg et al., 1995). In addition, the waste lines on all three channels were increased in length from 30 to 50 cm, using 1.0 mm ID tubing. The additional tubing prevents bubbles from passing into the flow cell, by maintaining slight back pressure on the system.

A new air-conditioning system was installed in the laboratory for this cruise, to provide a more constant temperature environment for chemical analyses. For most of the time, laboratory temperature was maintained at $22 \pm 2^\circ\text{C}$ (see Table 23 in the main text), a significant improvement on previous cruises.

A3.1.1.1 Silicate

Reactive silicate was analysed in accordance with the method provided for seawater analysis in the Alpkem Manual (Alpkem Corp, 1992). The silica in solution as silicic acid or silicate reacts with a molybdate reagent in acid media to form a molybdo silicic acid. The complex is then reduced to a highly coloured molybdenum blue following mixing with ascorbic acid. Interference from phosphate is suppressed by the addition of oxalic acid. Absorbance is measured at 660 nm.

Two modifications to the Alpkem methodology were introduced. Firstly, the reaction cartridge was thermostated to 37°C , to avoid the effects of any ambient temperature fluctuations on the sensitivity of the chemistry (Smythe-Wright et al., 1992, report that there may be up to 3% deviation in peak height with a 1°C change in temperature when using this chemistry). Secondly, the EVA tubing carrying the reaction product from the cartridge to the detector was fed between two layers of Tygon™ tubing, effectively forming an insulation jacket around the line.

A3.1.1.2 Nitrate plus nitrite

Nitrate plus nitrite was analysed using an Imidazole buffer chemistry in place of the Alpkem methodology. A 12" Open Tubular Cadmium Reactor (OTCR) supplied by Alpkem is used for quantitative reduction of nitrate to nitrite. The nitrite due to nitrate, plus the nitrite originally present in the sample, then undergoes diazotization with sulphanilamide and subsequent coupling with N-1-naphthylethylene-diamine dihydrochloride. The azo dye is detected at 540 nm. A standard nitrite solution is used frequently to check the reduction efficiency of the column. Efficiencies over 95% are commonly achieved. The columns are re-activated with a 2% copper sulphate solution after every second analysis run. Details of the chemistry and procedures for nitrate plus nitrite analysis follow.

Methodology for nitrate plus nitrite analysis in seawater

All reagents are analytical grade (AR), unless otherwise specified. All volumetric glassware for reagent preparation is A grade dedicated glassware, and cleaned with acid prior to each voyage. Glassware is stored full of deionised water when not in use.

Reagent chemistry

Start-up solution: Add 0.5 ml of 30% w/v Brij-35 to 200 ml of deionised water. Mix thoroughly. This reagent is refreshed daily.

Imidazole buffer pH 7.8: Dissolve 4.25 g of Imidazole buffer in 800 ml of deionised water. Add 11.25 ml of 10% HCl to adjust the final pH to 7.8. Make up to a litre and mix well. Add 1 ml of 30% w/v Brij-35 after decanting liquid to reagent container. Store at 4°C when not in use. Replenish every 2 to 3 days.

N-1 naphthylethylene-diamine dihydrochloric acid (NEDD): Dissolve 0.31 g of NEDD in 1 l of deionised water. Add 1 ml of 30% w/v Brij-35 after decanting to reagent container. Store at 4°C when not in use.

Sulphanilamide: Dissolve 3.12 g of sulphanilamide in 800 ml of deionised water in a 1 l volumetric flask. Add 31 ml of concentrated HCl carefully, and make up to the mark.

Pump configuration

Reagent	Pump tube	Flow rate at 50% pump speed
NEDD	Orange/yellow	0.18 ml/ min
Sulphanilamide	Orange/yellow	0.18 ml/min
Imidazole Buffer	Black/black	0.32 ml/min
Nitrogen	Orange/white	0.25 ml/min
Sample	Black/black	0.32 ml/min

Activation of the OTCR

The activation and installation of the OTCR is performed in accordance with the method in the Alpkem Manual (Alpkem Corp, 1992). A separate batch of Imidazole buffer, that does not contain Brij-35, is used for the activation of the OTCR. When not in use, OTCR's are stored filled with deionised water, or high purity nitrogen.

Figure A3.1: Cartridge configuration for nitrate + nitrite analysis.

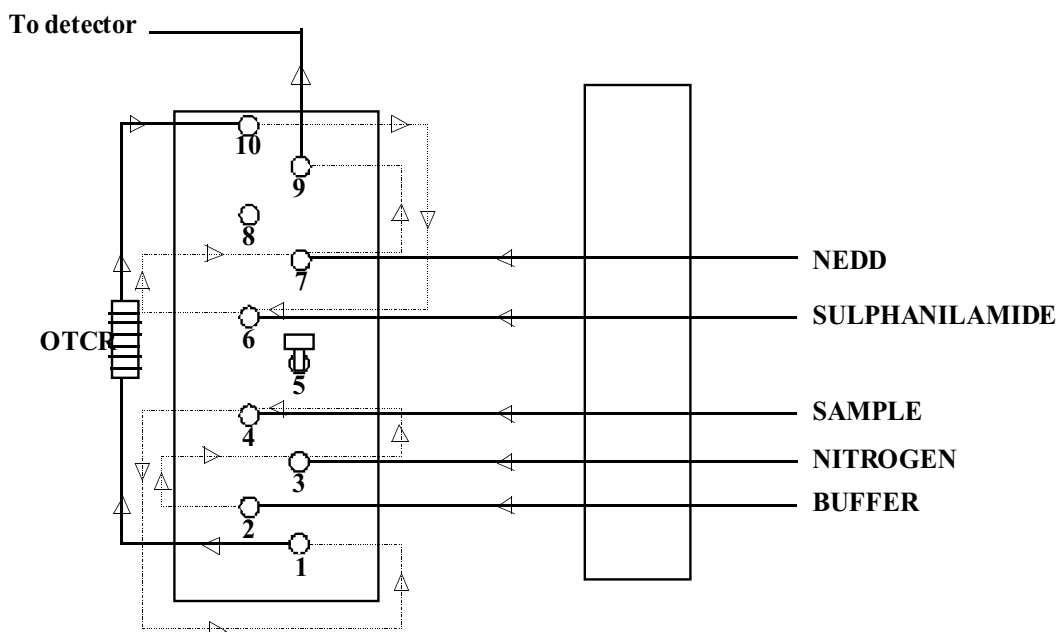

A3.1.1.3 Phosphate

Phosphate analysis was carried out using the methodology supplied by Alpkem (Alpkem Corp, 1992). The chemistry involves reaction with an acidified molybdate reagent and potassium antimonyl ttrate. The compound produced is then reduced by ascorbic acid to a highly coloured molybdenum blue complex. The chemistry uses a single colour reagent, which has a shelf life of 8 hours and must be renewed accordingly. The pump tubing was optimised to reduce the effect of carryover on samples. The monochromator detector was modified to increase the upper wavelength selection limit from 800 to 900 nm. It was found that using 880 nm as the detection wavelength, instead of 660 nm as recommended by Alpkem, increased the sensitivity of the method by 30%.

Pump configuration

Reagent	Pump tube	Flow rate at 50% pump speed
Dowfax	Red/red	0.71 ml/ min
Air	Black/black	0.32 ml/min
Sample	Red/red	0.71 ml/min
Mixed colour reagent	Orange/green	0.10 ml/min

A3.1.2 Sampling procedure

Nutrients were sampled after dissolved gases and salinity samples had been drawn. Typically, 30 to 45 minutes lapsed between the arrival of the CTD on deck and sampling for nutrients. Duplicate samples were collected in 12 ml polypropylene screw cap tubes with a 10 ml mark to prevent overfilling. Tubes and caps were rinsed three times with approximately half the volume of the tube before drawing the final sample (see section 4.1.4 in the main text).

For the SR3 transect, pairs of tubes were placed into polystyrene trays, and snap frozen without any chemical preservation. When required, samples were thawed, mixed thoroughly and placed directly into the autosampler, so that no sample transfers were necessary. The racks of the autosampler had been specially modified by Alpkem to take the 12 ml sample tubes. Experiments conducted at CSIRO Division of Oceanography (R. Plaschke, unpublished notes) have shown that with careful thawing procedures, silicate samples processed within one week of freezing undergo no significant loss of silicate by polymerisation.

On the PET transect, conditions were such that samples could be analysed directly, without freezing. Samples were left capped until equilibrated to room temperature, and were mixed thoroughly before analysis. If a delay was experienced, the samples were refrigerated until required. The duplicate was frozen as an emergency backup. All frozen duplicate samples were returned to Hobart and retained until data processing was completed.

It is intended that immediate analysis will become a routine part of the analysis procedure on future cruises, to overcome any potential problems encountered with freezing and thawing of seawater samples.

A3.1.3 Calibration and standards

Standard ranges used for nutrient analyses are shown in Table A3.1. Combined standards were prepared daily using an Eppendorf Multipette and dedicated A grade volumetric glassware, using artificial seawater made from high purity reagents as a diluent. For the northernmost shallow stations of the SR3 transect, where silicate levels are depleted, a low range of silicate standards was used to increase the precision of the determinations. The calibration standards were run prior to analysing each station, in order to check the linearity of detector response, and to calculate the calibration factor required to convert peak height of an unknown sample to a concentration in $\mu\text{mol/l}$.

Stock standards were prepared from analytical grade reagents prior to departure of the cruise. The new batch of stock standard nutrient solutions were compared to the previous batch of stock standards as a QC check.

Table A3.1: Range of calibration standards and concentration of QC standards used for analysis of nutrients on SR3 and PET transects.

Nutrient	Range of standards used ($\mu\text{mol/l}$)	QC standard ($\mu\text{mol/l}$)
Reactive silicate (high range) as Na_2SiF_6	0, 28, 56, 84, 112, 140	140
Reactive silicate (low range) as Na_2SiF_6	0, 7, 14, 21, 28, 35	35
Orthophosphate as KH_2PO_4	0, 0.6, 1.2, 1.8, 2.4, 3.0	3
Nitrate plus nitrite as KNO_3	0, 7, 14, 21, 28, 35	35

A3.1.4 Low Nutrient Sea Water (LNSW)

LNSW is prepared from high purity NaCl, and used as a diluent for standard solutions and as the wash solution in the analytical manifold. If pure water were used as a wash solution, each peak on the phosphate and nitrate channels would be accompanied by a significant spike as the interface between pure water and seawater alternately refracts and focuses light on the photodiode. The data processing software DAPA cannot be programmed to ignore the refractive index spike, and so erroneous concentrations would be reported. By using artificial seawater, of similar salinity to the samples, the refractive index disturbance that occurs when a pure water baseline is used is eliminated. Even the highest purity NaCl, however, can be significantly contaminated with respect to phosphate. A background colour reagent is used to correct for traces of phosphate present in the wash solution and also in the analytical reagents.

A3.1.5 Temperature effects and corrections

During the previous cruise (Rosenberg et al., 1995) there was no temperature regulation in the hydrographic laboratory, resulting in fluctuations in sensitivity of the silicate channel of up to 20% in one day. It was not possible to maintain a stable environment, so the worst analysis runs were rejected and repeated. Those stations still showing a drift in silicate sensitivity were corrected for drift by applying a linear gain adjustment available in the data processing software DAPA. During the course of an analytical run, quality control standards are interspersed at regular intervals. These QC standards are equivalent in concentration to the top standard for each nutrient, and are used to check for drift, carryover etc. Adjacent pairs of QC standards were measured and compared, and the heights of sample peaks that fell between them were corrected by linear interpolation. (The concentration of calibration and QC standards are shown in Table A3.1.)

During this cruise, there was still some evidence of fluctuating sensitivity of the silicate channel. The frequency and scale of the resulting drift was dramatically reduced relative to the previous cruise, however a correction was still required for some stations. The drift correction was applied to silicate data for all stations, rather than arbitrarily selecting the worse runs for reprocessing. In addition, a drift correction was applied to the nitrate+nitrite data for station 61. On future cruises, all nutrient data will be automatically corrected for any gain or loss of sensitivity during the course of the analytical run.

When data processing in DAPA is completed, the data is imported into the program HYDRO where it is merged with the relevant cruise and station data.

A3.2 DISSOLVED OXYGEN ANALYSIS

A3.2.1 Equipment and technique

The methodology for dissolved oxygen analysis used by the Antarctic CRC was reviewed after the previous cruise (AU9309/AU9391), and found to be in need of significant improvement. As a result, an automated dissolved oxygen system was commissioned to replace the manual titration method that had been used for previous cruises. The new methodology is based on the automated system developed by Woods Hole Oceanographic Institution (WHOI) (Knapp et al., 1990).

The new method has the following advantages over the manual system:

- * It utilises the Carpenter (1965) reagent chemistry specified by WOCE (WOCE Operations Manual, 1991).
- * It requires the measurement of a reagent blank, to correct for reducing impurities.
- * There is a significant improvement in precision and accuracy.
- * The system only requires standardisation every second day, instead of daily.
- * The standardisation method is such that any loss of volatile iodine incurred in the process of collecting an aliquot of sample is taken into account.
- * There is a reduction in operator error, as the whole titration process is controlled by computer.
- * Data is directly acquired by computer, reducing the data processing time.
- * The system is extremely seaworthy and can be used reliably in rough weather, when manual titrations can be exceptionally difficult.
- * The method is used by a number of organisations participating in the WOCE program.

The new system was trialled at sea and on shore before being adopted for routine analysis. The results of these trials, and the equations used for the calculation of dissolved oxygen concentration, are detailed in Eriksen and Terhell (in prep.)

There were several amendments made to the Knapp et al. (1990) automated method, to accommodate the equipment available at the Antarctic CRC. 300 ml sample bottles were used in place of the recommended 150 ml bottles. As a result, 2.0 ml of each of the pickling reagents was added at the time of sampling, and 2.0 ml of 10N H₂SO₄ was used to acidify samples prior to analysis. The

calculation value for total amount of oxygen added with reagents was then 0.034 ml, as opposed to 0.017 ml in the Knapp et al. (1990) method. Table A3.2 summarises the details of the automated dissolved oxygen method. Note that duplicate titrations were performed every 6 samples as a check on the reproducibility of titrations.

Table A3.2: Summary of details of WHOI automated oxygen method (Knapp et al., 1990).

Modifications to the WHOI automated method include:

(a) 300 ml sample bottles are used rather than 150 ml (*note a* in the table), and subsequently

(b) 2 ml of reagents are added to the sample bottle rather than 1 ml (*note b* in the table).

Endpoint:	Amperometric
Bottle volume:	300 ml (<i>note a</i>)
Aliquot volumes:	50 ml
Size of burette:	10 ml
Smallest measurable volume increment (l):	1
Standard solution:	0.01N KH(IO ₃) ₂
Standard preparation:	Vacuum dried
Standard volume:	15 ml
Blank determined:	Yes
Blank tests for:	Redox species in reagents plus bias in measured endpoint
Blank result used in calculations:	Yes
Scope for negative blank:	Yes
Mn reagent in standards:	Yes
Standardise daily:	No
Thiosulphate normality:	0.01 N
Reagent chemistry:	3 M MnCl ₂ (2 ml) (<i>note b</i>) 8 N NaOH/4 M NaI (2 ml) (<i>note b</i>) 10 N H ₂ SO ₄ (2 ml) (<i>note b</i>)
Reagent filtering:	All double filtered
Final sample pH:	2
Specified reaction time:	2-4 hours
Correction for DO in reagents:	Yes
Standard and sample handling procedures the same:	Yes
Average sample processing time:	1.5-2 minutes

A3.2.2 Sampling procedure

Samples were drawn in accordance with the protocols documented in section 4.1.4 of the main text.

A3.3 SALINITY ANALYSIS

A3.3.1 Equipment and technique

Salinity analysis was conducted using a YeoKal Mark 4 Inductively Coupled Salinometer (Yeokal Electronics, Sydney Australia). The manufacturer claims that with sufficient care, and in a constant temperature environment, an experienced operator should be able to attain an accuracy of ± 0.003 psu.

The salinometer was standardised daily using IAPSO P-series salinity standards, in accordance with WOCE guidelines. Immediately after the standardisation procedure was completed, the conductivity ratio of a bulk seawater "substandard" was measured. The substandard was then measured in triplicate every 10 samples, to monitor the electronic drift of the instrument. If the drift exceeded 0.00005 conductivity units, then another vial of IAPSO International seawater was used to check the calibration of the instrument. Samples were left for 12 to 24 hours to equilibrate to room temperature before analysing. The station to be analysed next was always positioned beside the substandard and international standard, to ensure that all three fell within the same temperature compensation bandwidth. The YeoKal salinometers do not have a thermostated bath around the conductivity cell, thus the temperature at which conductivity ratios are determined is also measured, and must be confined to a narrow range.

A3.3.2 Sampling procedure

Samples were collected in accordance with the protocol detailed in section 4.1.4 of the main text.

A3.3.3 Data processing

Conductivity ratios were entered manually into the HYDRO program, which calculates salinity (PSS-78) from the conductivity and calibration data acquired on the salinometer. The program also calculates and corrects for any instrument drift by linear interpolation between pairs of substandard observations.

REFERENCES

- Alpkem Corporation, 1992. *"The Flow Solution" Operation Manual*. Alpkem Corporation 9445 SW Ridder Rd Wilsonville, OR 97070 USA.
- Carpenter, J.H., 1965. The Chesapeake Bay Institute technique for the Winkler Dissolved Oxygen method. *Limnology and Oceanography*. **10**: 141-143.
- Eriksen, R. (in prep.). *A Practical Manual for the Determination of Salinity, Dissolved Oxygen and Nutrients in Seawater*. Antarctic CRC Technical Report, Hobart.
- Eriksen, R. and Terhell, D., (in prep.). *A Comparison of Manual and Automated Methods for the Determination of Dissolved Oxygen in Seawater*. Antarctic CRC Technical Report, Hobart.
- Knapp, G.P., Stalcup, M.C., and Stanley, R.J., 1990. *Automated Oxygen Titration and Salinity Determination*. Woods Hole Oceanographic Institution Technical Report WHOI-90-35.
- Rosenberg, M., Eriksen, R. and Rintoul, S., 1995. *Aurora Australis marine science cruise AU9309/AU9391 - oceanographic field measurements and analysis*. Antarctic Cooperative Research Centre, Research Report No. 2, March 1995. 103 pp.

Smythe-Wright, D., Paylor, R. and Holley, S., 1992. *Chemical tracer studies as IOSDL-3. The measurement of silicate, nitrate and phosphate in seawater.* Institute of Oceanographic Sciences Deacon Laboratory, Report No. 302, 1992. 73 pp.

WOCE Operations Manual, 1991. WHP Office Report WHPO 91-1, WOCE Report No. 68/91, Woods Hole, Mass., USA.

APPENDIX 4 Data File Types

A4.1 UNDERWAY MEASUREMENTS

The underway measurements for the cruise, as logged automatically by the ship's data logging system, and quality controlled by human operator (Ryan, 1995), are contained in column formatted ascii files. The two file types contain 10 sec digitised data, and 15 min averaged data. In both cases, missing data or data flagged as bad are replaced by the null value -999. The files are padded out to commence on the first digitising interval of the first day in the file, and ending at the last digitising interval on the last day in the file.

A4.1.1 10 second digitised underway measurement data

Data at the minimum digitised interval of 10 sec. are contained in files named *.alf (Table A4.1), where the data filename prefix corresponds to the cruise acronym ("sham"). A two line header is followed by the data as follows:

column	parameter
1	decimal time (0.0=midnight on December 31st, therefore, for example, 1.5=midday on January 2nd)
2	day
3	month
4	year
5	hour
6	minute
7	second
8	latitude (decimal degrees, +ve=north, -ve=south)
9	longitude (decimal degrees, +ve=east, -ve=west)
10	depth (m)
11	sea surface temperature (°C) (measured at the seawater inlet at 7 m depth)

Note that all times are UTC.

Table A4.1: Example 10 sec digitised underway measurement file (*.alf file).

Aurora Australis data - GPS pos. (deg), depth (m), sea surface temp (deg C)

decimaltime	day	mn	yr	hr	m	s	lat	lon	depth	SST
70.00000004	12	3	1993	0	0	0	-999.0000	-999.0000	-999.0	-999.00
70.00011578	12	3	1993	0	0	10	-999.0000	-999.0000	-999.0	-999.00
70.00023148	12	3	1993	0	0	20	-44.0044	146.3534	284.6	15.20
70.00034722	12	3	1993	0	0	30	-44.0044	146.3529	-999.0	15.20
70.00046296	12	3	1993	0	0	40	-44.0044	146.3530	283.5	15.20
70.00057870	12	3	1993	0	0	50	-44.0044	146.3523	287.4	15.20
70.00069444	12	3	1993	0	1	0	-44.0043	146.3519	282.2	15.20
70.00081019	12	3	1993	0	1	10	-44.0044	146.3515	282.4	15.20
70.00092593	12	3	1993	0	1	20	-44.0044	146.3511	283.3	15.20
70.00104167	12	3	1993	0	1	30	-44.0044	146.3507	286.0	15.20
70.00115741	12	3	1993	0	1	40	-44.0044	146.3507	286.3	15.20
70.00127315	12	3	1993	0	1	50	-44.0044	146.3502	286.8	15.20
70.00138889	12	3	1993	0	2	0	-44.0043	146.3498	287.4	15.20
70.00150463	12	3	1993	0	2	10	-44.0043	146.3493	291.0	15.20

A4.1.2 15 minute averaged underway measurement data

15 minute averaged data are contained in files named *.exp (Table A4.2), where the data filename prefix corresponds to the cruise acronym ("sham"). Note that wind direction and ship's heading are instantaneous values. All times represent the *centre* of the averaging interval. A two line header is followed by the data as follows:

column	parameter
1	decimal time (as for 10 sec digitised files)
2	latitude (as for 10 sec digitised files)
3	longitude (as for 10 sec digitised files)
4	air pressure (hecto Pascals)
5	wind speed (knots)
6	wind direction (deg. true)
7	port air temperature (°C)
8	starboard air temperature (°C)
9	port relative humidity (%)
10	starboard relative humidity (%)
11	quantum radiation ($\mu\text{mol/s/m}^2$)
12	ship speed (knots) (speed through the water)
13	ship heading (deg. true)
14	ship roll (deg.)
15	ship pitch (deg.)
16	sea surface salinity (parts per thousand) (from seawater inlet at 7 m depth)
17	sea surface temperature (°C) (at seawater inlet, 7 m depth)
18	average fluorescence (arbitrary units) (from seawater inlet at 7 m depth)
19	seawater flow (l/min) (flow rate at seawater inlet)

Note that all times are UTC.

Table A4.2: Example 15 min averaged underway measurement file (*.exp file).

```
Aurora Australis DLS data: dumped by EXPORT. Column units: days,deg,deg,hPa,knots,degTrue,degC,degC,%,%,umol/s/m2,knots,degTrue,deg,deg,ppt,degC, -,l/min
decimaltime lat long airP windsp windd poairT stairT pohum sthum grad shipspd shiphdg roll pitch ssSAL ssT avfluo seaflo
70.00520833 -44.00310 146.33583 1022.2 19.6 293 14.2 14.2 93 88 -999 6.56 235.5 1.185341 0.486591 35.175 15.20 -999.000 9.95
70.01562500 -44.00076 146.31305 1022.3 22.1 290 14.2 14.3 92 87 -999 1.15 235.5 1.295333 0.346111 35.165 15.10 -999.000 9.97
70.02604167 -44.00056 146.31239 1022.3 20.6 305 14.0 14.0 94 89 -999 0.00 235.5 2.568000 0.287667 35.159 15.10 -999.000 9.98
70.03645833 -44.00036 146.31232 1022.2 20.6 298 14.1 14.0 94 89 -999 0.00 235.5 1.303000 0.274444 35.165 15.10 -999.000 9.99
70.04687500 -44.00000 146.31136 1022.2 20.1 298 14.0 14.0 95 90 -999 0.00 234.5 1.380111 0.433667 35.166 15.10 -999.000 9.99
70.05729167 -43.99958 146.31143 1022.2 20.7 288 14.1 14.1 94 89 222 0.00 234.5 1.801667 0.464667 35.165 15.10 -999.000 9.97
70.06770833 -43.99918 146.31229 1022.3 18.5 295 13.8 14.1 96 90 170 0.00 234.5 1.619333 0.398334 35.164 15.20 -999.000 9.99
```

A4.2 2 DBAR AVERAGED CTD DATA FILES

The final format in which CTD data is distributed is as 2 dbar averaged data, contained in column formatted ascii files, named *.all (Table A4.3) (the filename prefix is discussed in Appendix 2). Averaging bins are centered on even pressure values, starting at 2 dbar. A 15 line header is followed by the data, as follows:

column	parameter
1	pressure (dbar)
2	temperature (°C) (ITS-90)
3	salinity (psu)
4	$\sigma_T = \text{density}-1000$ (kg.m ⁻³)
5	specific volume anomaly x 10 ⁸ (m ³ .kg ⁻¹)
6	geopotential anomaly (J.kg ⁻¹)
7	dissolved oxygen (μmol.l ⁻¹)
8	number of data points used in the 2 dbar averaging bin
9	standard deviation of temperature values in the 2 dbar bin
10	standard deviation of conductivity values in the 2 dbar bin
11	fluorescence (mg.m ⁻³) (uncalibrated)
12	photosynthetically active radiation (μmol.s ⁻¹ .m ²) (uncalibrated)

All files start at the 2 dbar pressure level, incrementing by 2 dbar for each new data line. Missing data are filled by blank characters (this most often applies to dissolved oxygen data).

Table A4.3: Example 2 dbar averaged CTD data file (*.all file).

```
SHIP : R.V. Aurora Australis
STATION NUMBER : 4
DATE : 02-JAN-1994 (DAY NUMBER 2)
START TIME : 1020 UTC = Z
BOTTOM TIME : 1100 UTC = Z
FINISH TIME : 1222 UTC = Z
CRUISE : Au94/07
START POSITION : 44:07.03S 146:13.35E
BOTTOM POSITION : 44:07.14S 146:13.71E
FINISH POSITION : 44:06.61S 146:13.95E
MAXIMUM PRESSURE: 1038 DECIBARS
BOTTOM DEPTH : 1015 METRES
```

PRESS	TEMP	SAL	SIGMA-T	S.V.A.	G.A.	D.O.	fluorescence	p.a.r.
(T-90)								
2.0	11.899	34.773	26.432	158.69	0.032	277.6	30 0.001 0.007	0.95569E+01 -0.49498E+00
4.0	11.899	34.778	26.436	158.41	0.063	280.3	30 0.001 0.001	0.10817E+02 -0.63459E+00
6.0	11.903	34.779	26.436	158.46	0.095	281.1	45 0.001 0.002	0.90911E+01 -0.60488E+00
8.0	11.903	34.778	26.435	158.55	0.127	278.0	41 0.000 0.000	0.80700E+01 -0.58265E+00
10.0	11.903	34.778	26.435	158.60	0.159	278.6	32 0.001 0.001	0.75122E+01 -0.66496E+00
12.0	11.904	34.778	26.435	158.66	0.190	280.2	32 0.001 0.001	0.72758E+01 -0.55944E+00
14.0	11.905	34.778	26.435	158.72	0.222	281.5	40 0.000 0.000	0.73697E+01 -0.62194E+00
16.0	11.907	34.779	26.435	158.76	0.254	277.5	34 0.002 0.002	0.69932E+01 -0.56719E+00
18.0	11.908	34.780	26.435	158.77	0.286	275.7	25 0.002 0.002	0.68356E+01 -0.63807E+00
20.0	11.909	34.779	26.435	158.90	0.317	276.0	30 0.002 0.002	0.69607E+01 -0.54045E+00
22.0	11.911	34.780	26.435	158.93	0.349	275.3	63 0.003 0.003	0.69971E+01 -0.59554E+00
24.0	11.917	34.781	26.435	158.95	0.381	265.2	47 0.004 0.006	0.69678E+01 -0.58176E+00
26.0	11.923	34.783	26.435	159.01	0.413	268.1	31 0.002 0.003	0.70108E+01 -0.63026E+00
28.0	11.909	34.779	26.434	159.11	0.444	272.3	26 0.002 0.002	0.68240E+01 -0.57804E+00

A4.3 HYDROLOGY DATA FILES

Files named *.bot (where the filename prefix is the the cruise code e.g. a9407) are column formatted ascii files containing the hydrology data, together with CTD upcast burst data (Table A4.4). The columns contain the following values:

column	parameter
1	station number
2	CTD pressure (dbar)
3	CTD temperature (°C)
4	reversing thermometer temperature (°C)
5	CTD conductivity (mS.cm ⁻¹)
6	CTD salinity (psu)
7	bottle salinity (psu)
8	ortho phosphate concentration (μmol.l ⁻¹)
9	nitrate + nitrite concentration (μmol.l ⁻¹)
10	reactive silicate concentration (μmol.l ⁻¹)
11	bottle dissolved oxygen concentration (μmol.l ⁻¹)
12	bottle quality flag (-1=rejected, 0=suspect, 1=good)
13	niskin bottle number

Missing data values are filled by a decimal point (surrounded by blank characters). Parameters 2,3,5 and 6 are mean values from the upcast CTD burst data at the time of bottle firing, where each burst contains the data 5 sec previous to the time of bottle firing. Parameters 7 to 11 are laboratory values for the hydrology analyses. Parameter 12, the bottle quality flag, is relevant to the calibration of CTD salinities - bottles flagged 1 and 0 are used for calibration, while those flagged -1 are rejected. Criteria for flagging of the bottle data are discussed elsewhere (Appendix 2). Parameter 13, the niskin bottle number, is a unique identifier for each bottle. Note that the bottle number does not always correspond with rosette position.

Table A4.4: Example hydrology data file (*.bot file).

2	8.556	15.155	15.154	43.109	35.032	35.031	0.29	8.80	7.7	247.10	1	11
2	25.593	15.111	.	43.076	35.034	35.035	0.28	0.20	3.7	248.50	1	9
2	50.992	15.105	.	43.085	35.038	35.038	0.27	0.30	2.2	249.10	1	8
2	73.718	14.188	.	42.227	35.068	35.077	0.48	4.40	2.8	228.70	-1	7
2	98.376	12.840	.	40.910	35.055	35.051	0.66	7.70	2.5	227.60	-1	6
2	123.524	12.490	.	40.618	35.089	35.081	0.76	9.60	3.0	223.10	-1	5
2	148.516	11.904	.	40.025	35.052	35.067	0.85	11.10	3.4	223.30	-1	4
2	200.278	11.085	.	39.174	34.963	34.965	0.90	13.30	4.0	226.40	-1	3
2	247.807	10.678	10.691	38.758	34.914	34.914	1.02	13.90	4.1	230.40	0	2
2	289.188	9.625	.	37.640	34.769	34.794	1.13	15.80	4.8	232.40	-1	1
3	8.609	15.984	15.958	44.199	35.274	35.275	.	0.20	1.6	270.80	1	16
3	21.504	15.975	.	44.198	35.276	35.275	0.25	0.20	1.5	266.60	1	15
3	48.210	15.935	.	44.171	35.277	35.276	0.25	0.40	0.7	264.60	1	14
3	73.795	15.897	.	44.140	35.273	35.270	0.27	0.80	1.6	238.30	-1	13
3	98.905	14.011	.	42.238	35.229	35.236	0.63	7.50	2.3	.	-1	12
3	148.674	12.557	.	40.763	35.155	35.155	0.81	10.90	4.1	216.00	0	11
3	197.813	11.432	.	39.575	35.033	35.033	0.92	12.80	3.9	227.30	1	10
3	298.658	10.110	.	38.158	34.828	34.831	1.10	15.40	4.6	230.70	1	9
3	396.295	9.214	.	37.238	34.702	34.703	1.28	18.70	6.0	226.20	-1	8
3	496.675	8.371	.	36.405	34.604	34.603	1.52	22.50	9.3	210.60	1	7
3	597.207	7.385	.	35.469	34.524	34.524	1.71	25.90	14.6	199.30	1	6
3	697.115	6.587	.	34.751	34.487	34.486	1.90	28.30	20.6	195.30	1	5
3	778.707	5.739	.	33.995	34.458	34.458	2.05	30.50	27.8	.	1	4
3	900.509	4.315	.	32.710	34.381	34.382	2.20	32.70	33.6	198.50	1	3
3	1000.091	4.027	4.029	32.574	34.471	34.471	2.34	34.30	49.6	171.00	1	2
3	1113.395	3.403	.	32.110	34.517	34.522	2.42	35.40	61.3	169.90	-1	1
4	23.926	15.341	.	43.397	35.121	35.120	0.26	0.10	0.6	230.60	1	23
4	49.736	15.198	.	43.231	35.088	35.087	0.26	0.30	0.6	229.10	1	22
4	99.651	13.388	.	41.599	35.202	35.200	0.77	9.00	2.6	200.60	1	21
4	148.952	12.164	.	40.341	35.114	35.122	0.86	12.90	3.8	221.80	-1	20
4	196.847	11.114	.	39.222	34.985	34.980	0.95	11.40	3.6	233.30	-1	19
4	298.033	9.997	.	38.028	34.804	34.803	1.02	13.80	.	254.10	-1	18
4	384.198	9.235	.	37.228	34.676	34.677	.	.	.	256.20	-1	17
4	495.853	8.452	.	36.455	34.578	34.577	1.43	20.70	8.1	232.70	-1	16

A4.4 STATION INFORMATION FILES

Station information files, named *.sta (Table A4.5) (where the filename prefix is the cruise code), contain position, time, bottom depth and maximum pressure of cast for CTD stations. The CTD instrument number is specified in the file header. Position and time (UTC) are specified at the start, bottom and end of the cast, while the bottom depth is for the start of the cast. Note that small inconsistencies may exist between bottom depth and maximum pressure, due to drift of the vessel between the start and bottom of the cast. In addition, a single value is assumed for the sound velocity in seawater for echo sounder calculations (1498 m.s^{-1}), which may cause small errors in water depth values.

Table A4.5: Example CTD station information file (*.sta file).

RSV Aurora Australis Cruise : Au93/09 CTD station list (CTD unit 4)													
stat no.	time	date	start latitude	start longitude	bottom depth(m)	max P (dbar)	time	bottom latitude	bottom longitude	time	end latitude	end longitude	
1	2032	11-MAR-93	44:06.73S	146:14.35E	1000	956	2118	44:06.37S	146:14.35E	2154	44:06.19S	146:14.60E	
2	0027	12-MAR-93	44:00.06S	146:18.61E	300	289	0042	44:00.03S	146:18.77E	0115	43:59.97S	146:18.64E	
3	0513	12-MAR-93	44:07.51S	146:14.89E	1100	1115	0549	44:07.48S	146:15.06E	0632	44:07.39S	146:15.23E	
4	0854	12-MAR-93	44:27.89S	146:07.94E	2340	2335	0938	44:27.52S	146:07.30E	1028	44:27.32S	146:07.51E	
5	1437	12-MAR-93	44:56.71S	145:56.67E	3380	3465	1606	44:56.10S	145:56.52E	1727	44:55.56S	145:56.36E	

REFERENCES

Ryan, T., 1995. *Data Quality Manual for the data logged instrumentation aboard the RSV Aurora Australis..* Australian Antarctic Division, unpublished manuscript, second edition, April 1995.

APPENDIX 5 Data Processing Information

Table A5.1: Upcast CTD bursts automatically flagged during creation of intermediate CTD files (Appendix 2).

station number	rosette position		station number	rosette position	
	flag=-1	flag=0		flag=-1	flag=0
1 SR3		19,22,24	56 SR3		23
2 SR3	14	15,17,22	57 SR3	21	22,24
3 SR3	1,2,9,11,12	5,8,10,13	58 SR3	21,22	20,23,24
4 SR3	1,19,20	3,7,8,15,17	59 SR3		22,24
5 SR3		11,14,15,17,19	60 SR3		21,23
6 SR3	20,21	11,12,13	61 SR3	22	4,5,7,13,14,16,17,18,23
7 SR3	4		63 SR3	20,23	22
8 SR3	12,14,21,22	15,16,17,20	64 SR3	19	22,23
9 SR3	22	15,20,21	65 SR3	19	6,16,17,18,20
10 SR3	21	19,20	66 SR3		5,6,10,12,23
11 SR3	16	14	67 SR3	11,12,17,21,24	2,9,10,14,16,20
12 SR3		13,22	68 SR3	6,17	11,13,14,20
13 SR3	19,20	10,11,17,18	69 SR3	13,14	3,4,5
14 SR3	13,20		70 SR3	13	4,5,7
15 SR3	20	12,13,14	71 SR3		9
16 SR3		13,14	72 SR3	14	13,15
17 SR3	20	17,18	73 SR3		8
19 SR3	18,19,22	13,15,17	74 ULS	3,11	4,17,21
20 SR3	14		75 ULS	19,23	
21 SR3		18	76 PET	19,21	15,17,20
22 SR3		18	77 PET	19,21	
23 SR3		14,21	78 PET	10	12,14,15,18,19,21
24 SR3	14	11,12,15,21	79 PET	16	9,14,21,22,23
25 SR3	17,22	3,21	80 PET	19	12,20,22,23,24
26 SR3	14,23	17,19	81 PET	22,23	14,15
30 SR3	15	16,17,18,19,20	82 PET	15,18,19,23	
32 SR3	18,21,23	22	83 PET	17,19,21	15,18,20,22
33 SR3	19,22	18,21	84 PET	22	21,24
34 SR3		21	85 PET	19,21,22,23,24	
35 SR3		20,21	86 PET	9,11,12,13,15	3,5,6,7,10,16,20
36 SR3	24	19,20,21,22,23	87 PET	22	15
37 SR3		19,20,21,24	88 PET	21,22	19,23
39 SR3	15,21,23,24	10,16,17,18	89 PET	5,7,9,11,13,14	10,12
40 SR3	24		91 PET	21,22	
41 SR3	24	20,22	92 PET	21	22,23
42 SR3	18,20	22,23	93 PET	22	
43 SR3	11,13,17,19,22	14,15,21	94 PET		3
44 SR3		20	95 PET	21	20,22,23,24
45 SR3	21	20	96 PET	18,19	17,21,22
46 SR3	20		97 PET	16,17,21,23	14,15,19,20,24
48 SR3	20	21,23	98 PET	14,15,17	
49 SR3	11,12,23	14,18,19,20,22	99 PET	15,16,17,19	13,20
51 SR3		21,22	100 TS	11,12,13,15,16,17,18	5,14,19
52 SR3	8,10	9	101 TS	6,7,23	
53 SR3		23,24	102 BPR	13,14	15,20
54 SR3	21,24				
55 SR3	21,22	20			

Table A5.2: Dissolved oxygen Niskin bottle samples flagged as -9 for dissolved oxygen calibration. Note that this does not necessarily indicate a bad bottle sample - in many cases, flagging is due to bad CTD dissolved oxygen data.

station number	rosette position	station number	rosette position	station number	rosette position
3	1	42	17,18,19,20	71	11
4	19	45	20,21	74	3
5	16,21	46	18,19,20	75	19
7	2	47	21	76	20
13	14	48	21	77	17,19
15	12,17	51	21,22	79	8,13
17	22	54	21	81	14,24
19	15,16,17	55	19	83	8,18
20	23,24	58	21	84	22
23	16	60	22	86	18
24	15,21,24	63	20	91	21
26	18	64	21	98	16
30	16	65	18,19	99	14,20
33	18,19,20	68	11,15,17	100	12,18
39	18	69	13,15	102	13,14
40	23	70	11		

Table A5.3: Stations containing fluorescence (fl) and photosynthetically active radiation (par) 2 dbar-averaged data.

stations with fl data	stations with par data
1	1
3,4,5	3,4,5
7	7
11	11 to 102
16	
21	
39	
43	
76,77,78,79,80,81	
83	
86	
89,90,91,92,93,94,95,96,97,98,99,100	

Table A5.4: Protected and unprotected reversing thermometers used for cruise AU9407 (serial numbers are listed).

protected thermometers

station numbers	rosette position 24 thermometers	rosette position 2 thermometers	rosette position 18 thermometers
1 to 101	12095,12096	12094,11973	-
102	12095,12096	12094,11973	12120,12119

unprotected thermometers

station numbers	rosette position 2 thermometers	rosette position 18 thermometers
1 to 101	11992	-
102	11992	11993

APPENDIX 6 Historical Data Comparisons

A6.1 INTRODUCTION

In this Appendix, a brief comparison is made between the au9407 cruise data, and data from the previous cruise au9309; data from the SR3 transect only is discussed. The SR3 transect was occupied during the autumn of 1993, and summer of 1993/94, for cruises au9309 and au9407 respectively. For data prior to 1993, see Appendix 6 in Rosenberg et al. (1995).

The following terminology is used for the discussion in this Appendix (taken from Patterson and Whitworth, 1990):

Subantarctic Zone - lying between the Subtropical and Subantarctic Fronts;

Subantarctic Front - as defined by Gordon et al. (1977); marked by a rapid southward decrease in surface temperature and salinity;

Polar Frontal Zone - transition zone between the Subantarctic and Polar Fronts;

Polar Front - as defined by Emery (1977); marked by the northern terminus of the well defined subsurface temperature minimum layer;

Antarctic Zone - south of the Polar Front;

TS curves and vertical profiles of dissolved oxygen and nutrients from a series of locations along the SR3 transect are compared for the two cruises (Figure A6.1). Although some nomenclature differences exist in the literature when discussing the Southern Ocean, particularly for meridional transitions in water characteristics, the above definitions are used as convenient references for selecting representative stations for the inter-cruise comparison. Positions for all stations referred to in Figure A6.1 are listed in Table A6.1. Note that the stations selected for graphing in Figure A6.1 display most, but not all, of the general trends discussed below: it is difficult to simultaneously display all these trends without graphing the entire data set.

Table A6.1: Positions for all stations referred to in Figure A6.1.

	au9309			au9407		
	stn	lat. S	long. E	stn	lat. S	long. E
Subantarctic Zone	12	48:18.91	144:32.00	17	48:18.90	144:31.73
Subantarctic Zone	14	49:16.18	144:05.26	20	49:16.17	144:05.64
Polar Frontal Zone	21	52:15.27	142:37.50	29	52:15.46	142:37.53
Polar Frontal Zone	22	52:38.18	142:23.56	31	52:39.41	142:22.88
Antarctic Zone	27	55:01.15	141:00.75	37	55:01.16	141:00.58
Antarctic Zone	30	56:26.22	140:06.15	41	56:26.28	140:06.01
Antarctic Zone	42	60:21.22	139:50.86	51	60:21.36	139:50.59
Antarctic Zone	43	60:21.34	139:50.91			
Antarctic Zone	48	61:50.76	139:51.22	55	61:51.11	139:50.95
Antarctic Zone	49	61:51.06	139:51.58			
Antarctic Zone	56	63:50.89	139:51.75	60	63:52.03	139:51.10
Antarctic Zone	57	63:47.35	139:54.20			
Antarctic Zone	62	65:05.06	139:51.08	64	65:04.98	139:50.91
Antarctic Zone	63	65:04.89	139:51.27			

A6.2 RESULTS

A6.2.1 CTD temperature and salinity

Comparison of TS diagrams for the two cruises (Figure A6.1a to e) reveals a relative decrease in salinities for au9407 data over most of the water column. This unexpected result is particularly surprising for the Circumpolar Deep Water. Comparison of meridional variation of the salinity maximum for the two cruises i.e. for Lower Circumpolar Deep Water (as defined by Gordon, 1967) (Figure A6.2) reveals a large consistent relative decrease in salinity for au9407 data, of the order 0.006 psu. Note that in Figure A6.2, property differences are only formed between station pairs (i.e. corresponding au9309 and au9407 stations) which are separated by less than 1.5 nautical miles of latitude; north of $\sim 47.5^\circ$ south, station locations for the two cruises do not correspond spatially.

On initial inspection, the consistent deep water salinity difference between the two cruises suggests some systematic error in the salinity data. In particular, temperature and pressure differences at the salinity maxima are randomly scattered about zero (Figure A6.2), suggesting that there is a biasing of the salinity measurements for one of the cruises (no biasing exists for either the temperature or pressure data). However, at the time of writing, comparison of au9309 data with the latest salinity data from the SR3 transect in January 1995 (unpublished) reveals a comparable decrease in salinity at many locations i.e. agreement between au9407 and the January 1995 data. Comparison of the au9309 data with earlier data from cruise au9101 (Figure A6.3) shows a possible salinity increase for au9309 south of $\sim 49^\circ$ south. This increase is however not comparable to the large salinity difference between cruises au9309 and au9407.

The International Standard Seawater (ISS) batches used for salinity analyses during the different cruises are listed in Table A6.2. Note that the same batch was used for au9309 and for part of au9404. In particular, degradation of ISS batches with time would result in salinity increase of the ISS, in turn yielding a positive salinity bias for salinometer analyses. This is not consistent with the observed decrease in salinities from au9309 to au9407 and au9404. Thus the ISS is unlikely to account for the large salinity differences.

The only other possible source of a systematic salinity error is the salinometers. Different YeoKal Mk IV salinometers were indeed used for cruises au9309 and au9407 (Table A6.2). In addition, temperature control of the hydrology laboratory was only introduced just prior to cruise au9407. As a result, for cruise au9407 and later, salinity analyses were conducted at laboratory temperatures of ~ 22 to $23^\circ\text{C} \pm 2^\circ\text{C}$; whereas for cruise au9309, the average laboratory temperature was ~ 19 to 20°C (see Figure 2 in Rosenberg et al., 1995), and much larger fluctuations in temperature were experienced (up to $\sim \pm 10^\circ\text{C}$). Some as yet unknown inconsistency of salinometer behaviour, either a function of the instrument used or else the ambient temperature at which analyses occur, may indeed contribute to the observed salinity differences between cruises. Whether the entire difference can be attributed to systematic instrument error is, at this stage, inconclusive.

Table A6.2: International Standard Seawater (ISS) batches and salinometers used for different cruises.

cruise	station nos.	ISS batch no.	date of ISS	salinometer no.
au9309	1-63 (SR3)	P121	8th Sept. 1992	601003 (stations 1-63)
au9407	1-79 (SR3 and PET)	P123	10th June 1993	601855 (stations 1-86)
au9407	80-102 (PET)	P121	8th Sept. 1992	601003 (stations 87-102)
au9404	1-85 (S4 and SR3)	P123	10th June 1993	601855 (stations 1-107)
au9404	86-107 (SR3)	P121	8th Sept. 1992	

For the Polar Frontal Zone and more northerly parts of the Antarctic Zone (Figures A6.1b to d), surface waters for the au9309 data are fresher as a result of relatively higher precipitation during the autumn months. Further south (Figure A6.1e), surface waters are saltier for the au9309 data, due to removal of fresh water by the formation of sea ice.

Also worth noting is the temperature difference in the sub surface temperature minimum layer south of the Polar Front (Figures A6.1c to e). For cruise au9407, the minimum temperature in this layer is lower by up to $\sim 1^{\circ}\text{C}$, attributable to seasonal variability.

A6.2.2 Dissolved oxygen

Au9407 dissolved oxygen concentrations, measured using the WHOI automated method (see Appendix 3), are consistently higher than au9309 values, measured using the CSIRO manual method (Appendix 3 in Rosenberg et al., 1995), over the entire water column (Figures A6.1a to e). This observation is consistent with results found by Eriksen and Terhell (in prep.) when comparing the automated and manual analysis methods: concentrations analysed using the manual method are consistently lower by approximately 1%.

A6.2.3 Nutrients

Phosphate and nitrate+nitrite concentrations are in general consistent for the au9407 and au9309 data, revealed by comparison of the nitrate+nitrite to phosphate ratio (Figure A6.4). For more northerly stations (in the Subantarctic Zone), nitrate+nitrite concentrations are typically higher for au9309 data. These data can be seen (Figure A6.4) as a cluster of higher au9309 nitrate+nitrite values at the high concentration end of the scale. For phosphate data, au9309 concentrations are frequently lower in the more northerly parts of the Antarctic Zone, contributing to the clustering of au9309 data to the left of the best fit line at the higher concentration end of the scale in Figure A6.4. At latitudes other than those just mentioned, there is no consistent offset between phosphate and nitrate+nitrite data for the two cruises, with the exception of surface waters subject to high seasonal variability.

For stations south of $\sim 49^{\circ}$ south, silicate concentrations are more often higher for the au9309 data by, on average, ~ 3 to $5 \mu\text{mol/l}$. Exceptions to this pattern are for surface waters, where silicate values are usually lower for the au9309 data; and for data near the bottom in the Antarctic Zone, where no consistent silicate concentration offset between the two cruises is evident.

REFERENCES

- Emery, W.J., 1977. Antarctic Polar Front Zone from Australia to the Drake Passage. *Journal of Physical Oceanography*. **9**: 456-468.
- Eriksen, R. and Terhell, D., (in prep.). *A Comparison of Manual and Automated Methods for the Determination of Dissolved Oxygen in Seawater*. Antarctic CRC Technical Report, Hobart.
- Gordon, A.L., 1967. *Structure of Antarctic waters between 20°W and 170°W*. Antarctic Map Folio Series, Folio 6, Bushnell, V. (ed.). American Geophysical Society, New York.
- Gordon, A.L., Taylor, H.W. and Georgi, D.T., 1977. Antarctic oceanography zonation. In *Polar Oceans*, Dunbar, M.J. (ed.). Proceedings of the Polar Ocean Conference, McGill University, Montreal. Arctic Institute of North America, Calgary.
- Patterson, S.L. and Whitworth, T., 1990. *Chapter 3 Physical Oceanography in Antarctic Sector of the Pacific* (G.P. Glasby editor). Elsevier Oceanography Series, 51.
- Rosenberg, M., Eriksen, R. and Rintoul, S., 1995. *Aurora Australis marine science cruise AU9309/AU9391 - oceanographic field measurements and analysis*. Antarctic Cooperative Research Centre, Research Report No. 2, March 1995. 103 pp.

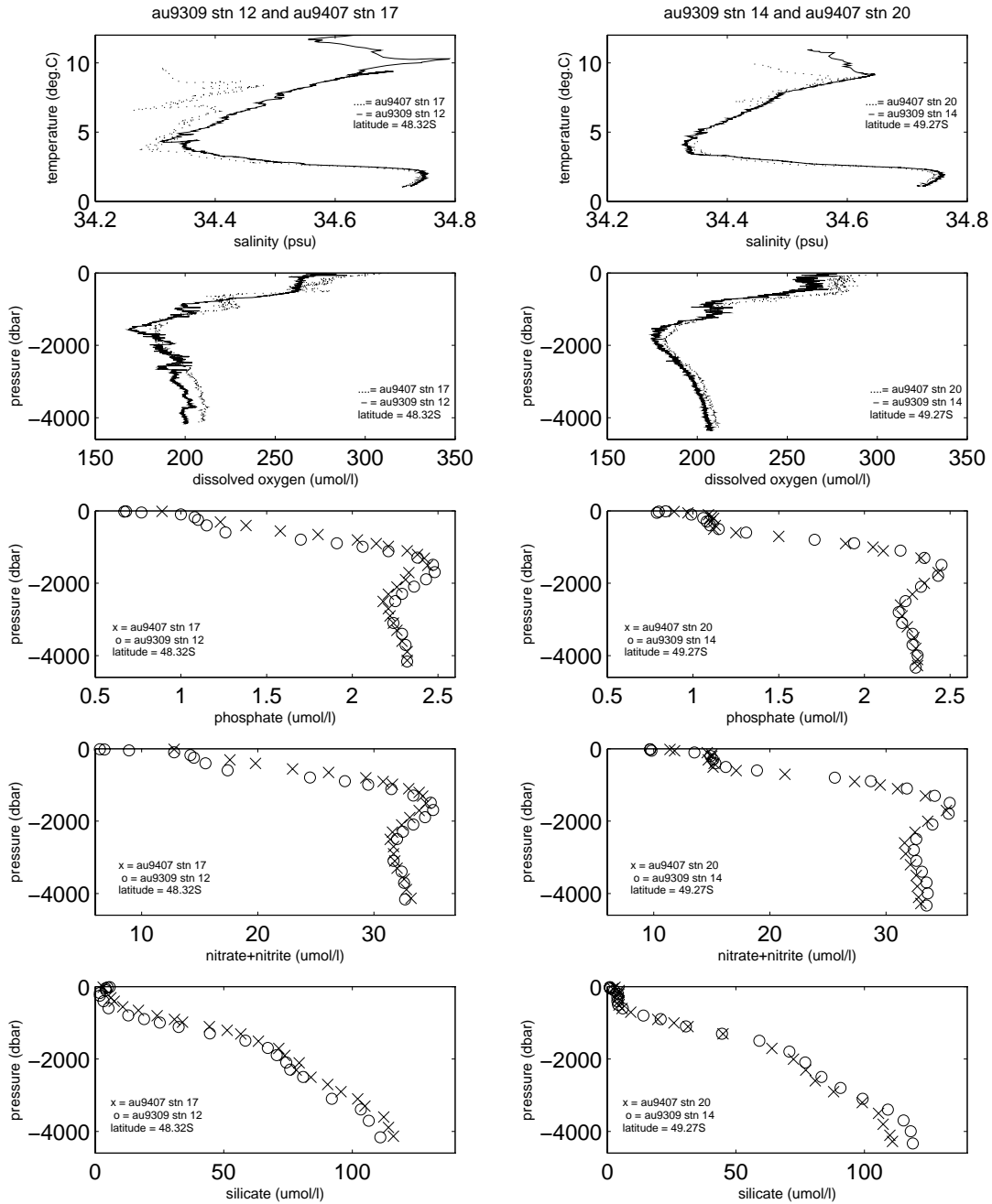

Figure A6.1a: TS diagrams, and dissolved oxygen and nutrient vertical profile data, for comparison of au9407 and au9309 data: stations north of the Subantarctic Front. Note that all dissolved oxygen data is CTD 2 dbar-averaged data.

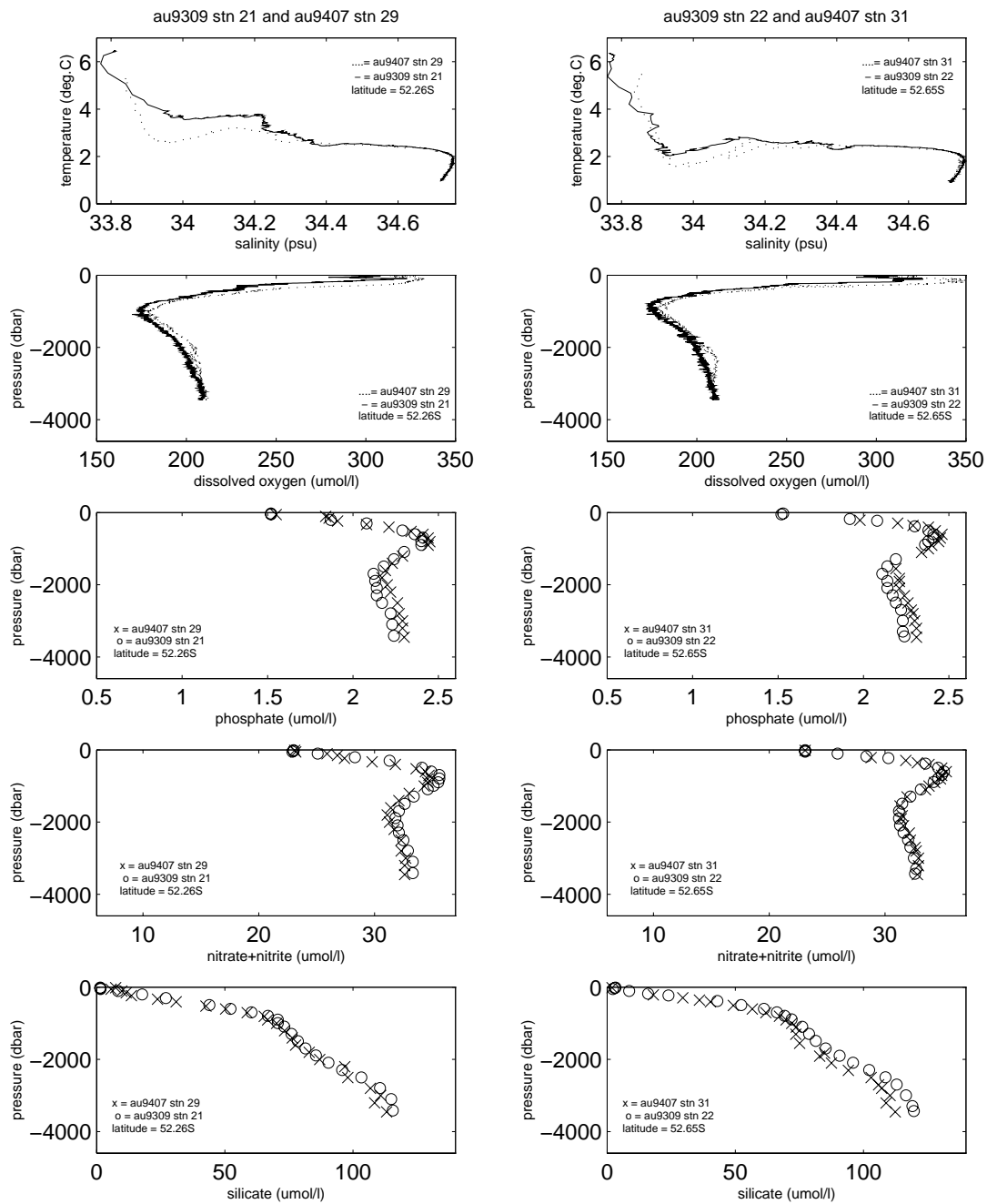

Figure A6.1b: TS diagrams, and dissolved oxygen and nutrient vertical profile data, for comparison of au9407 and au9309 data: stations between the Subantarctic and Polar Fronts. Note that all dissolved oxygen data is CTD 2 dbar-averaged data.

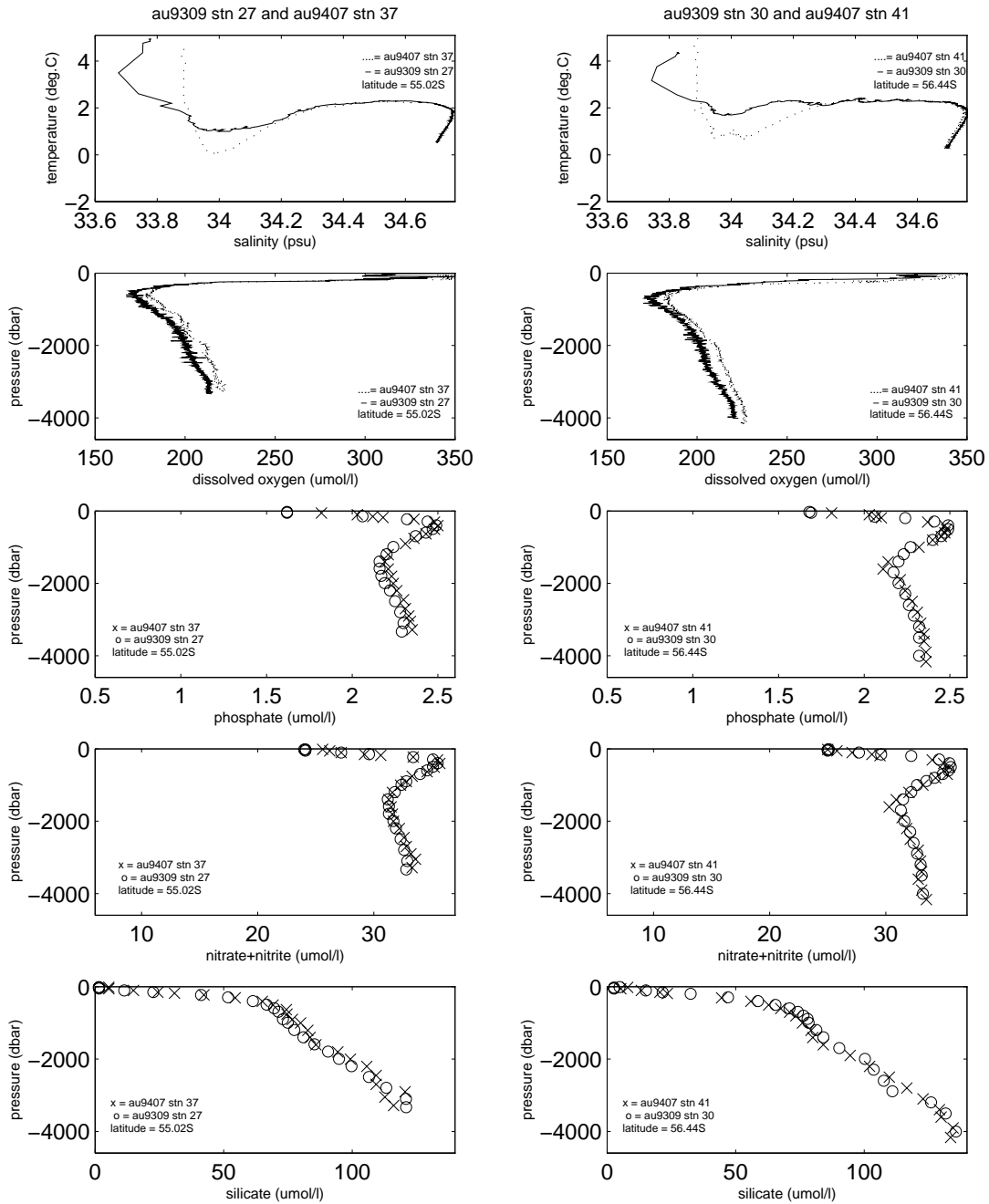

Figure A6.1c: TS diagrams, and dissolved oxygen and nutrient vertical profile data, for comparison of au9407 and au9309 data: stations south of the Polar Front. Note that all dissolved oxygen data is CTD 2 dbar-averaged data.

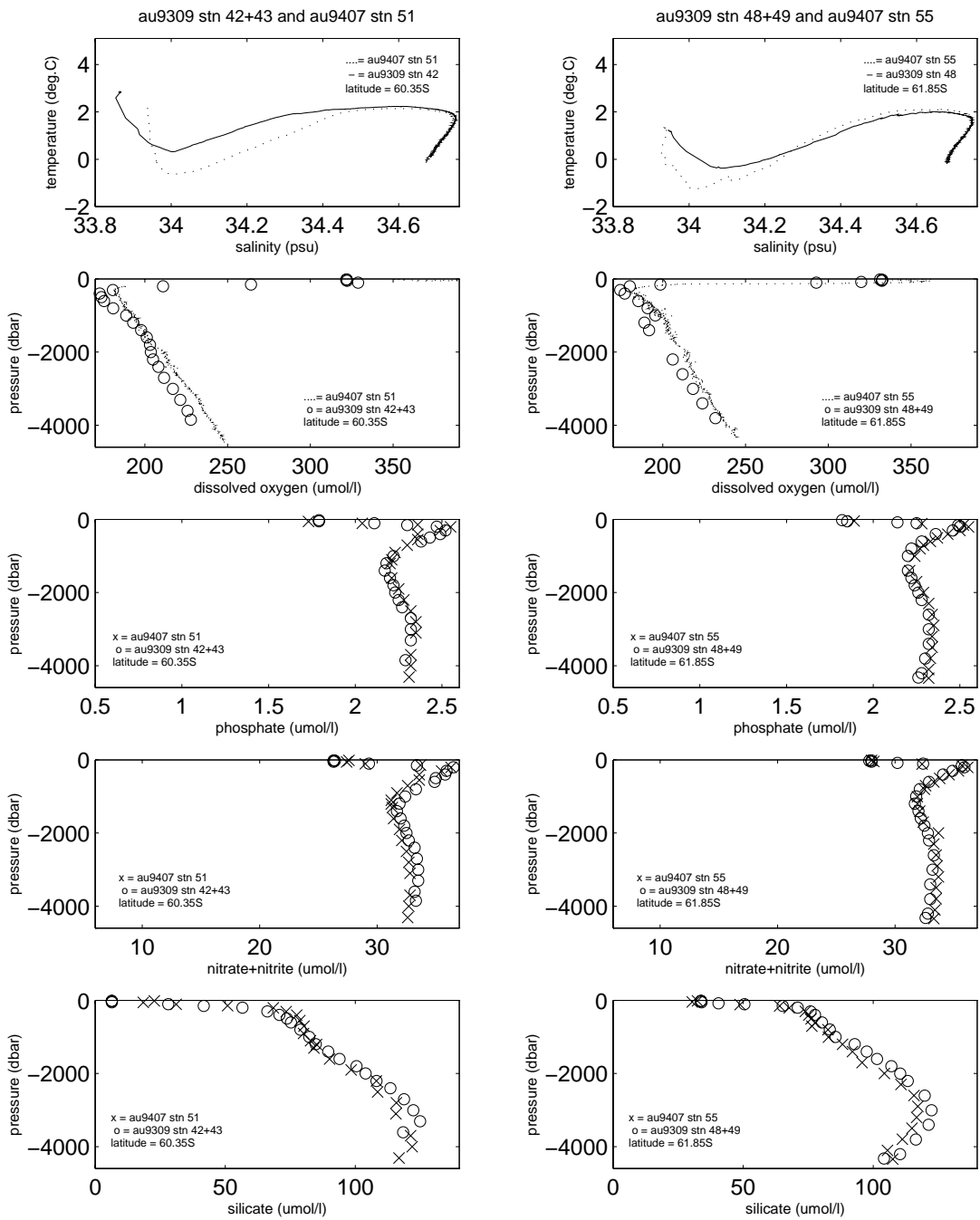

Figure A6.1d: TS diagrams, and dissolved oxygen and nutrient vertical profile data, for comparison of au9407 and au9309 data: stations south of the Polar Front. Note that dissolved oxygen data is CTD 2 dbar-averaged data for au9407, and Niskin bottle data for au9309.

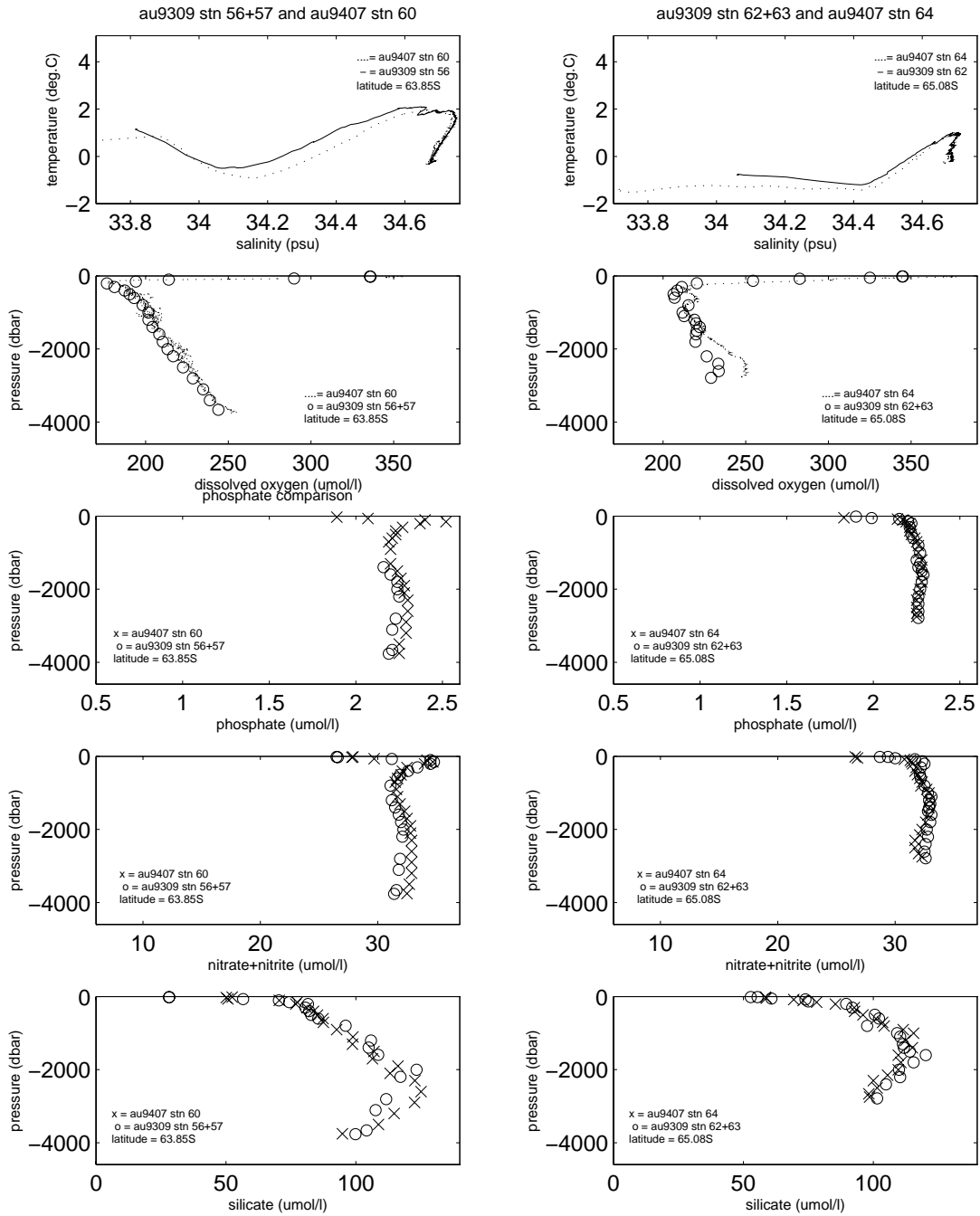

Figure A6.1e: TS diagrams, and dissolved oxygen and nutrient vertical profile data, for comparison of au9407 and au9309 data: stations south of the Polar Front. Note that dissolved oxygen data is CTD 2 dbar-averaged data for au9407, and Niskin bottle data for au9309.

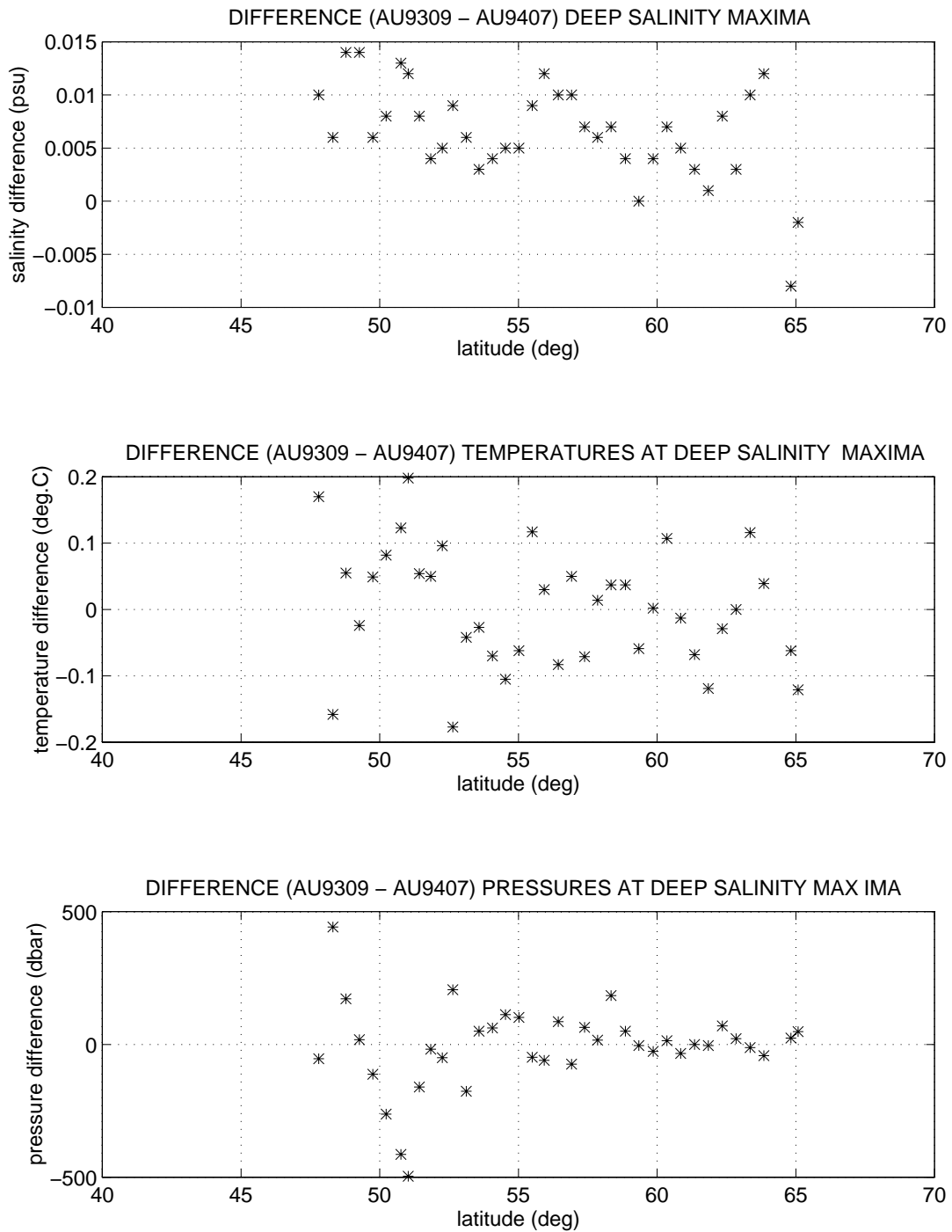

Figure A6.2: Variation with latitude south along the SR3 transect of properties at the deep salinity maximum (marking the Lower Circumpolar Deep Water): property differences are between cruise au9309 and cruise au9407 i.e. au9309 value minus au9407 value. Note that differences are formed only between stations from the two cruises which are separated by no more than 1.5 nautical miles of latitude.

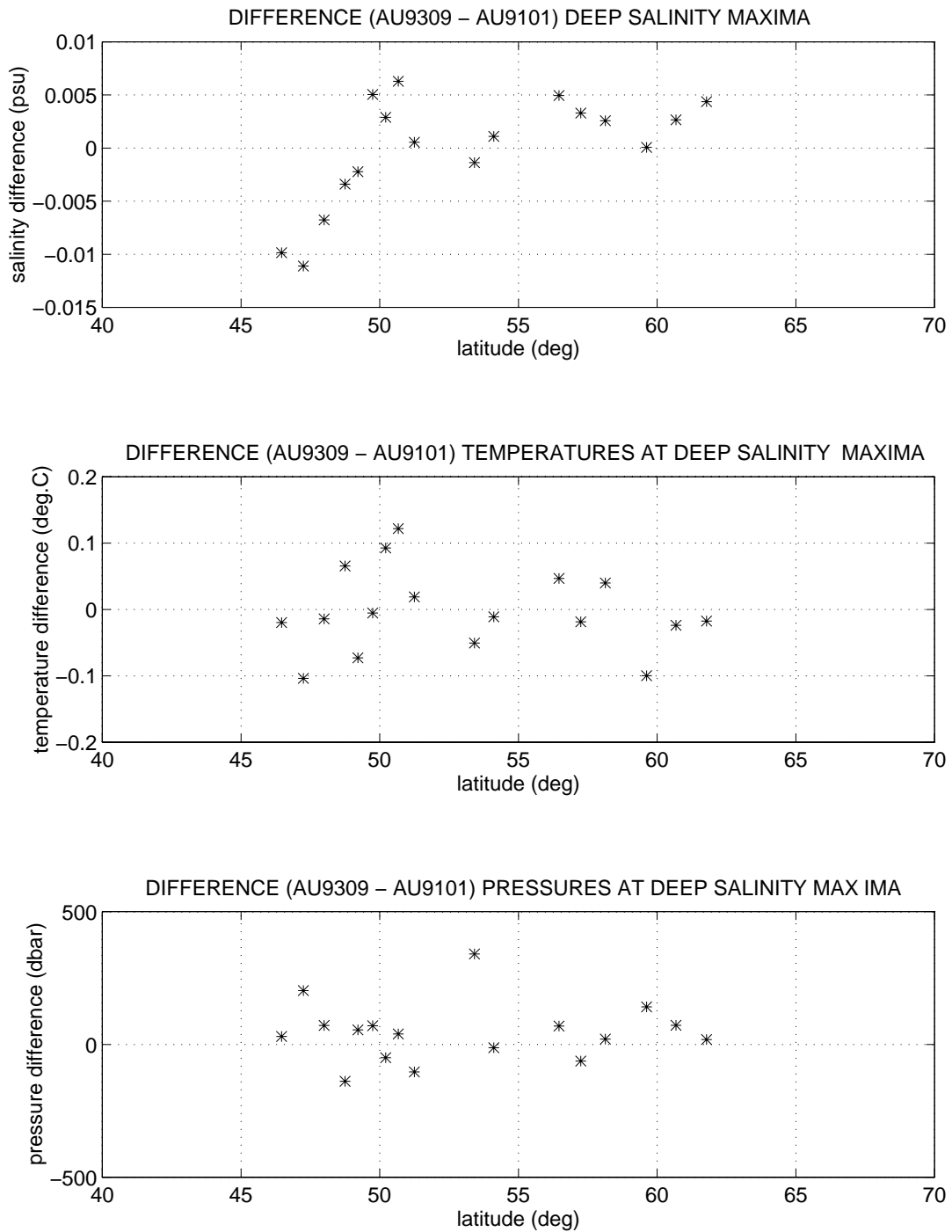

Figure A6.3: Variation with latitude south along the SR3 transect of properties at the deep salinity maximum (marking the Lower Circumpolar Deep Water): property differences are between cruise au9309 and cruise au9101 i.e. au9309 value minus au9101 value. Note that au9309 values are obtained by linearly interpolating between au9309 station latitudes to correspond with au9101 station latitudes.

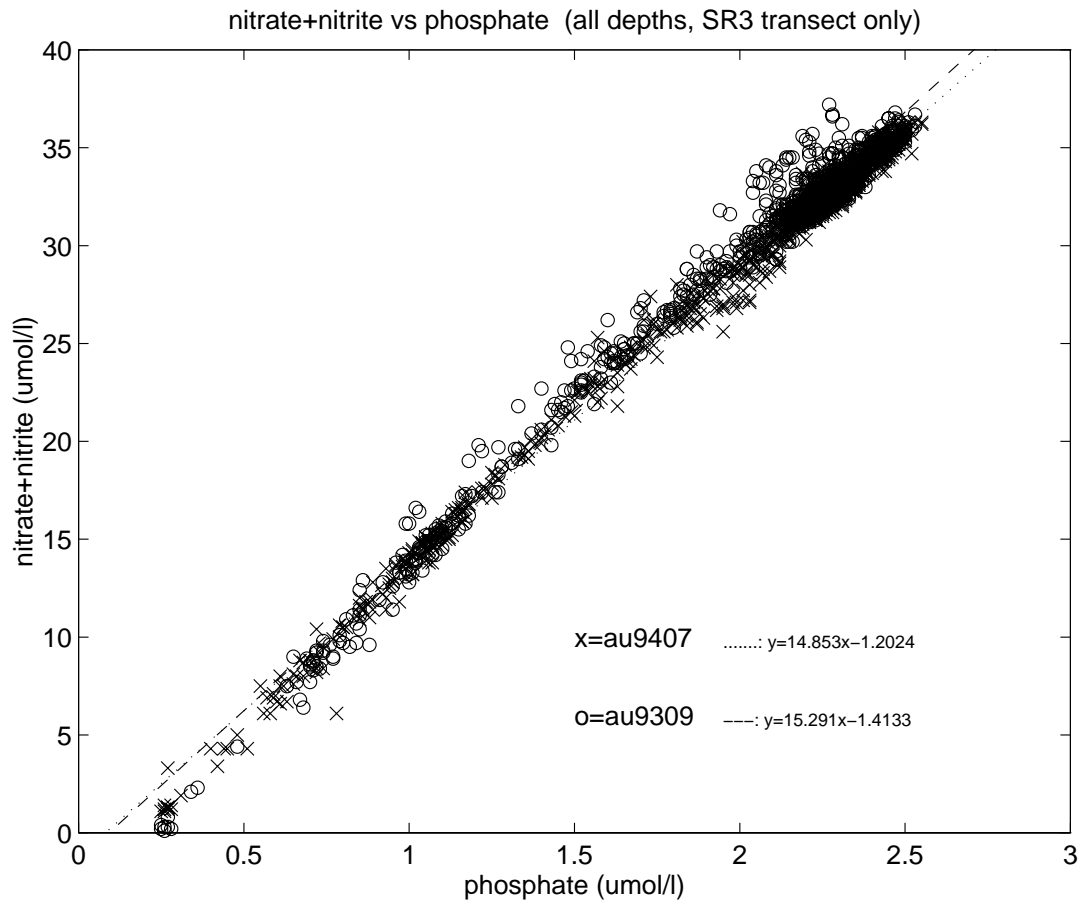

Figure A6.4: Bulk plot of nitrate+nitrite versus phosphate for all au9309 and au9407 data along the SR3 transect, together with linear best fit lines.

APPENDIX 7: WOCE Data Format Addendum

A7.1 INTRODUCTION

This Appendix is relevant only to data submitted to the WHP Office. For WOCE format data, file format descriptions as detailed earlier in this report should be ignored. Data files submitted to the WHP Office are in the standard WOCE format as specified in Joyce et al. (1991).

A7.2 CTD 2 DBAR-AVERAGED DATA FILES

- * CTD 2 dbar-averaged file format is as per Table 3.12 of Joyce et al. (1991), except that measurements are centered on even pressure bins (with first value at 2 dbar).
- * CTD temperature and salinity are reported to the third decimal place only.
- * Files are named as in Appendix 2, section A2.2.1, except that for WOCE format data the suffix “.all” is replaced with “.ctd”.
- * The quality flags for CTD data are defined in Table A7.1. Data quality information is detailed in earlier sections of this report.

A7.3 HYDROLOGY DATA FILES

- * Hydrology data file format is as per Table 3.7 of Joyce et al. (1991), with quality flags defined in Tables A7.2 and A7.3.
- * Files are named as in Appendix 2, section A2.2.2, except that for WOCE format data the suffix “.bot” is replaced by “.sea”.
- * The total value of nitrate+nitrite only is listed.
- * Silicate and nitrate+nitrite are reported to the first decimal place only.
- * CTD temperature (including theta), CTD salinity and bottle salinity are all reported to the third decimal place only.
- * CTD temperature (including theta), CTD pressure and CTD salinity are all derived from upcast CTD burst data; CTD dissolved oxygen is derived from downcast 2 dbar-averaged data (see Appendix 2).
- * Raw CTD pressure values are not reported.
- * SAMPNO is equal to the rosette position of the Niskin bottle.

A7.4 CONVERSION OF UNITS FOR DISSOLVED OXYGEN AND NUTRIENTS

A7.4.1 Dissolved oxygen

Niskin bottle data

For the WOCE format files, all Niskin bottle dissolved oxygen concentration values have been converted from volumetric units $\mu\text{mol/l}$ to gravimetric units $\mu\text{mol/kg}$, as follows. Concentration C_k in $\mu\text{mol/kg}$ is given by

$$C_k = 1000 C_l / \rho(\theta, s, 0) \quad (\text{eqn A7.1})$$

where C_l is the concentration in $\mu\text{mol/l}$, 1000 is a conversion factor, and $\rho(\theta, s, 0)$ is the potential density at zero pressure and at the potential temperature θ , where potential temperature is given by

$$\theta = \theta(T, s, p) \quad (\text{eqn A7.2})$$

for the *in situ* temperature T, salinity s and pressure p values at which the Niskin bottle was fired. Note that T, s and p are upcast CTD burst data averages (see Appendix 2, section A2.7.4).

CTD data

In the WOCE format files, CTD dissolved oxygen data are converted to $\mu\text{mol/kg}$ by the same method as above, except that T, s and p in eqns A7.1 and A7.2 are CTD 2 dbar-averaged data.

A7.4.2 Nutrients

For the WOCE format files, all Niskin bottle nutrient concentration values have been converted from volumetric units $\mu\text{mol/l}$ to gravimetric units $\mu\text{mol/kg}$ using

$$C_k = 1000 C_l / \rho(T_l, s, 0) \quad (\text{eqn A7.3})$$

where 1000 is a conversion factor, and $\rho(T_l, s, 0)$ is the water density in the hydrology laboratory at the laboratory temperature T_l and at zero pressure. T_l values used for each station are listed in Table 23 of the main text. Upcast CTD burst data averages are used for s.

Table A7.1: Definition of quality flags for CTD data (after Table 3.11 in Joyce et al., 1991). These flags apply both to CTD data in the 2 dbar-averaged *.ctd files, and to upcast CTD burst data in the *.sea files.

flag	definition
1	not calibrated with water samples
2	acceptable measurement
3	questionable measurement
4	bad measurement
5	measurement not reported
6	interpolated value
7,8	these flags are not used
9	parameter not sampled

Table A7.2: Definition of quality flags for Niskin bottles (i.e. parameter BTLNBR in *.sea files) (after Table 3.8 in Joyce et al., 1991).

flag	definition
1	this flag is not used
2	no problems noted
3	bottle leaking, as noted when rosette package returned on deck
4	bottle did not trip correctly
5	bottle leaking, as noted from data analysis
6	bottle not fired at correct depth, due to misfiring of rosette pylon
7,8	these flags are not used
9	samples not drawn from this bottle

Table A7.3: Definition of quality flags for water samples in *.sea files (after Table 3.9 in Joyce et al., 1991).

flag	definition
1	this flag is not used
2	acceptable measurement
3	questionable measurement
4	bad measurement
5	measurement not reported
6,8	these flags are not used
9	parameter not sampled

A7.5 STATION INFORMATION FILES

* File format is as per section 2.2.2 of Joyce et al. (1991), and files are named as in Appendix 2, section A2.2.3, except that for WOCE format data the suffix ".sta" is replaced by ".sum".

* All depths are calculated using a uniform speed of sound through the water column of 1498 ms⁻¹. Reported depths are as measured from the water surface. Missing depths are due to interference of the ship's bow thrusters with the echo sounder signal, as described in Appendix 2, section A2.3.

* An altimeter attached to the base of the rosette frame (approximately at the same vertical position as the CTD sensors) measures the elevation (or height above the bottom) in metres. The elevation value at each station is recorded manually from the CTD data stream display at the bottom of each CTD downcast. Motion of the ship due to waves can cause an error in these manually recorded values of up to ± 3 m.

* Lineout (i.e. meter wheel readings of the CTD winch) were unavailable.

REFERENCES

Joyce, T., Corry, C. and Stalcup, M., 1991. *Requirements for WOCE Hydrographic Programme Data Reporting*. WHP Office Report WHPO 90-1, Revision 1, WOCE Report No. 67/91, Woods Hole Oceanographic Institution. 71 pp.